

---

HP Notebook PC

---

Startup Guide

---

## Notice

This manual and any examples contained herein are provided “as is” and are subject to change without notice. Hewlett-Packard Company makes no warranty of any kind with regard to this manual, including, but not limited to, the implied warranties of merchantability and fitness for a particular purpose. Hewlett-Packard Co. shall not be liable for any errors or for incidental or consequential damages in connection with the furnishing, performance, or use of this manual or the examples herein.

Consumer transactions in Australia and the United Kingdom: The above disclaimers and limitations shall not apply to Consumer transactions in Australia and the United Kingdom and shall not affect the statutory rights of Consumers.

© Copyright Hewlett-Packard Company 2000–2001. All rights reserved. Reproduction, adaptation, or translation of this manual is prohibited without prior written permission of Hewlett-Packard Company, except as allowed under the copyright laws.

The programs that control this product are copyrighted and all rights are reserved. Reproduction, adaptation, or translation of those programs without prior written permission of Hewlett-Packard Co. is also prohibited.

Portions of the programs that control this product may also be copyrighted by Microsoft Corporation, Insyde Systems, Conexant Systems Incorporated, VIA Technologies Incorporated, ALPS Electric (USA) Incorporated, and Adobe Systems Incorporated. See the individual programs for additional copyright notices.

Microsoft®, MS-DOS®, and Windows® are U.S. registered trademarks of Microsoft Corporation. TrackPoint™ is a U.S. trademark of International Business Machines. Adobe® and Acrobat® are trademarks of Adobe Systems Incorporated.

**Hewlett-Packard Company**  
**HP Notebook Customer Care**  
**1000 NE Circle Blvd., MS 425E**  
**Corvallis, OR 97330, U.S.A.**

---

## Important safety information

---

### CAUTION

---

**To reduce the risk of fire, use only No. 26 AWG or larger telecommunications line cord to connect the modem to the telephone wall jack.**

When using your notebook with a telephone connection, always follow basic safety precautions to reduce the risk of fire, electric shock, and injury to persons:

- Do not use this product with a telephone connection near water, for example, near a bathtub, sink, swimming pool, or in a wet basement.
- Avoid using a telephone connection (other than a cordless type) during an electrical storm. There may be a remote risk of electric shock from lightning.
- Do not use a telephone connection of any type to report a gas leak while in the vicinity of the leak.
- Use only the power cord and batteries indicated in this manual. Do not dispose of batteries in a fire. They may explode. Check with local codes for possible special disposal instructions.

---

## HP Software Product License Agreement

Your HP product contains software programs. CAREFULLY READ THIS LICENSE AGREEMENT BEFORE PROCEEDING TO OPERATE THIS EQUIPMENT. RIGHTS IN THE SOFTWARE ARE OFFERED ONLY ON THE CONDITION THAT THE CUSTOMER AGREES TO ALL TERMS AND CONDITIONS OF THE LICENSE AGREEMENT. PROCEEDING TO OPERATE THE EQUIPMENT INDICATES YOUR ACCEPTANCE OF THESE TERMS AND CONDITIONS. IF YOU DO NOT AGREE WITH THE TERMS OF THE LICENSE AGREEMENT, YOU MUST NOW EITHER REMOVE THE SOFTWARE FROM YOUR HARD DISK DRIVE AND DESTROY THE MASTER DISKETTES, OR RETURN THE COMPLETE HP PRODUCT AND SOFTWARE FOR A FULL REFUND. PROCEEDING WITH CONFIGURATION SIGNIFIES YOUR ACCEPTANCE OF THE LICENSE TERMS.

UNLESS OTHERWISE STATED BELOW, THIS HP SOFTWARE LICENSE AGREEMENT SHALL GOVERN THE USE OF ALL SOFTWARE THAT IS PROVIDED TO YOU AS PART OF THE HP PRODUCT AND SHALL SUPERSEDE ANY OTHER SOFTWARE WARRANTY STATEMENT THAT MAY BE INCLUDED IN THIS HP PRODUCT OR MAY BE FOUND ONLINE.

Operating system and software applications by Microsoft are licensed to you under the Microsoft License Agreement contained in the Microsoft documentation or displayed on your screen when Microsoft Software Products are launched.

For a PC supplied with a Microsoft operating system: When you start the PC and accept the Microsoft End-user License Agreement (“EULA”), your license rights are valid only if a Certificate of Authenticity (“COA”) label corresponding to your Microsoft operating system is provided with your PC. The COA label can usually be found on the bottom of the computer. If the COA label does not correspond to your Microsoft operating system or is missing, contact your HP reseller for details.

Other non-HP Software and Operating Systems are covered by the appropriate vendor license. The following License Terms govern the use of the HP software:

USE. Customer may use the software on any one HP product. Customer may not network the software or otherwise use it on more than one HP product. Customer may not reverse assemble or decompile the software unless authorized by law.

COPIES AND ADAPTATIONS. Customer may make copies or adaptations of the software a) for archival purposes or (b) when copying or adaptation is an essential step in the use of the software with an HP product so long as the copies and adaptations are used in no other manner.

**OWNERSHIP.** Customer agrees that he/she does not have any title or ownership of the software, other than ownership of the physical media. Customer acknowledges and agrees that the software is copyrighted and protected under the copyright laws. Customer acknowledges and agrees that the software may have been developed by a third party software supplier named in the copyright notices included with the software, who shall be authorized to hold the Customer responsible for any copyright infringement or violation of this Agreement.

**PRODUCT RECOVERY CD-ROM.** If your HP product was shipped with a product recovery CD-ROM: (i) The product recovery CD-ROM and/or support utility software may only be used for restoring the hard disk of the HP product with which the product recovery CD-ROM was originally provided. (ii) The use of any operating system software by Microsoft contained in any such product recovery CD-ROM shall be governed by the Microsoft License Agreement.

**TRANSFER OF RIGHTS IN SOFTWARE.** Customer may transfer rights in the software to a third party only as part of the transfer of all rights and only if Customer obtains the prior agreement of the third party to be bound by the terms of this License Agreement. Upon such a transfer, Customer agrees that his/her rights in the software are terminated and that he/she will either destroy his/her copies and adaptations or deliver them to the third party.

**SUBLICENSING AND DISTRIBUTION.** Customer may not lease, sublicense the software or distribute copies or adaptations of the software to the public in physical media or by telecommunication without the prior written consent of Hewlett-Packard.

**TERMINATION.** Hewlett-Packard may terminate this software license for failure to comply with any of these terms provided Hewlett-Packard has requested Customer to cure the failure and Customer has failed to do so within thirty (30) days of such notice.

**UPDATES AND UPGRADES.** Customer agrees that the software does not include updates and upgrades which may be available from Hewlett-Packard under a separate support agreement.

**EXPORT CLAUSE.** Customer agrees not to export or re-export the software or any copy or adaptation in violation of the U.S. Export Administration regulations or other applicable regulation.

**U.S. GOVERNMENT RESTRICTED RIGHTS.** Use, duplication, or disclosure is subject to HP standard commercial license terms and for non-DOD Departments and Agencies of the U.S. Government, the restrictions set forth in FAR 52.227-19(c)(1-2) (June 1987) Hewlett-Packard Company, 3000 Hanover Street, Palo Alto, CA 94304 U.S.A. Copyright (c) 2000–2001 Hewlett-Packard Company. All Rights Reserved. Customer further agrees that Software is delivered and licensed as “Commercial computer software” as defined in DFARS 252-227-7014 (June 1995) or as a “commercial item” as defined in FAR 2.101(a), or as “Restricted computer software” as defined in FAR 52.227-19 (or any equivalent agency regulation or contract clause), whichever is applicable. The Customer agrees that it has only those rights provided for such Software by the applicable FAR or DFARS clause or the HP standard software agreement for the product involved.

Support Policy for Support Pack of Operating Systems. HP provides end user support for HP PCs that use Microsoft Operating Systems, including its latest service packs. This support will be available within 30 days of the software being released.

---

## Edition History

|                     |              |
|---------------------|--------------|
| Edition 1 . . . . . | January 2002 |
| Edition 2 . . . . . | March 2002   |



This manual is printed on recycled paper.

---

## Contents

|                                                   |           |
|---------------------------------------------------|-----------|
| <b>Getting Started with Your HP Notebook.....</b> | <b>9</b>  |
| Taking Inventory .....                            | 10        |
| What's in the box?.....                           | 10        |
| To find more information .....                    | 11        |
| Identifying Parts of the Notebook .....           | 12        |
| Front view.....                                   | 12        |
| Back view .....                                   | 13        |
| Bottom view .....                                 | 14        |
| Status lights .....                               | 15        |
| Setting Up Your Notebook.....                     | 17        |
| Step 1: Install the battery .....                 | 17        |
| Step 2: Connect AC power .....                    | 19        |
| Step 3: Connect a phone line .....                | 20        |
| Step 4: Turn on the notebook .....                | 21        |
| Step 5: Set up Windows.....                       | 21        |
| Step 6: Register your notebook.....               | 22        |
| To connect to the Internet.....                   | 22        |
| <br>                                              |           |
| <b>Basic Operation.....</b>                       | <b>23</b> |
| Operating Your Notebook.....                      | 24        |
| To turn the notebook on and off .....             | 24        |
| To reset your notebook.....                       | 25        |
| To change the boot device.....                    | 26        |
| To use the touch pad.....                         | 26        |
| To use the Fn hot keys.....                       | 28        |
| Working in Comfort with a Notebook PC.....        | 29        |
| <br>                                              |           |
| <b>Batteries and Power Management .....</b>       | <b>31</b> |
| Using Battery Power .....                         | 32        |
| To check battery status .....                     | 32        |
| To respond to a low-battery warning .....         | 33        |
| To recharge the battery .....                     | 33        |
| <br>                                              |           |
| <b>Add-On Devices.....</b>                        | <b>35</b> |
| Installing Additional RAM.....                    | 36        |
| To install a RAM expansion module .....           | 36        |
| Replacing the Hard Disk Drive .....               | 38        |
| To replace the hard disk drive .....              | 38        |

|                                                            |           |
|------------------------------------------------------------|-----------|
| <b>Troubleshooting and Maintenance.....</b>                | <b>39</b> |
| Troubleshooting Techniques .....                           | 40        |
| Display problems.....                                      | 40        |
| Hard disk drive problems .....                             | 42        |
| Keyboard, touch pad, and mouse problems .....              | 42        |
| Performance problems .....                                 | 43        |
| Power and battery problems .....                           | 44        |
| Startup problems.....                                      | 45        |
| Testing the Hardware .....                                 | 46        |
| To run the e-DiagTools diagnostic tests .....              | 46        |
| Configuring Your Notebook .....                            | 48        |
| To run the BIOS configuration utility.....                 | 48        |
| Reinstalling and Updating Software .....                   | 50        |
| To recover the factory installation of your hard disk..... | 50        |
| <br>                                                       |           |
| <b>HP Service and Support .....</b>                        | <b>53</b> |
| Getting Assistance for Your Notebook .....                 | 54        |
| To get help from HP Instant Support.....                   | 54        |
| To get help from the web.....                              | 54        |
| To contact HP for support or service.....                  | 54        |
| To receive repair service .....                            | 56        |
| To prepare your notebook for shipment .....                | 57        |
| Hewlett-Packard Limited Warranty Statement.....            | 58        |
| <br>                                                       |           |
| <b>Reference Information.....</b>                          | <b>61</b> |
| Hardware Specifications.....                               | 62        |
| Safety Information.....                                    | 64        |
| Power cords .....                                          | 64        |
| Ergonomics.....                                            | 65        |
| Battery safety.....                                        | 65        |
| Laser safety.....                                          | 66        |
| Regulatory Information .....                               | 67        |
| U.S.A. ....                                                | 67        |
| <br>                                                       |           |
| <b>Index.....</b>                                          | <b>69</b> |

---

## Getting Started with Your HP Notebook

---

## Taking Inventory

Congratulations! Your HP notebook computer sets a new standard in personal computing. Although compact and easy to carry, your notebook is made with the quality and attention to detail that are the hallmark of Hewlett-Packard.

Your notebook has several features that make it convenient to use:

- The power button provides convenient options for starting and stopping the notebook.
- The notebook includes a variety of connectors that enable you to use it with a wide range of printers, drives, audio equipment, and other external devices.

In addition, most connectors are on or near the back of the notebook, keeping cables away from your working area.

This manual shows how to set up and operate your notebook, as well as what to do if you run into trouble.

---

## What's in the box?

Your HP notebook PC is shipped with these items:

- Battery (installed).
- AC adapter and power cord.
- *Quick Start* sheet.
- *Startup Guide*.
- *Recovery CDs*, for restoring Windows and all software included with your notebook.
- Microsoft Windows manual.
- Telephone cord.

In addition, your notebook includes a variety of preinstalled software. (The exact software installed depends on your particular notebook model.)

---

## To find more information

The following table lists sources of information about your notebook and related products.

| <b>Source</b>                 | <b>Description and Location</b>                                                                                                                                                                                                                                       |
|-------------------------------|-----------------------------------------------------------------------------------------------------------------------------------------------------------------------------------------------------------------------------------------------------------------------|
| <i>Quick Start</i> sheet      | This pictorial introduction shows you how to get your notebook up and running quickly.                                                                                                                                                                                |
| <i>Startup Guide</i>          | This printed manual introduces your HP notebook computer, and contains setup instructions, basic operation guidelines, troubleshooting information, and warranty information.                                                                                         |
| <i>Online Reference Guide</i> | The <i>Reference Guide</i> is shipped on the notebook's hard drive, and provides a complete source for operating and maintaining the notebook. Click Start, All Programs, HP Library, HP Notebook Reference Guide, or look on the <i>Recovery CDs</i> in \hp\library. |
| Online HP Notes               | These contain information that became available after the manuals were completed. Click Start, All Programs, HP Library, HP Notes, or look on the <i>Recovery CDs</i> in \hp\library.                                                                                 |
| Microsoft Windows manual      | This is shipped with your notebook and contains information about using the version of Microsoft Windows shipped with your notebook.                                                                                                                                  |
| HP Notebook web site          | <a href="http://www.hp.com/notebooks">www.hp.com/notebooks</a> .<br><a href="http://www.europe.hp.com/notebooks">www.europe.hp.com/notebooks</a> (European mirror).                                                                                                   |
| HP Business Support web site  | <a href="http://www.hp.com/go/bizsupport">www.hp.com/go/bizsupport</a> .                                                                                                                                                                                              |

---

## Identifying Parts of the Notebook

---

Front view

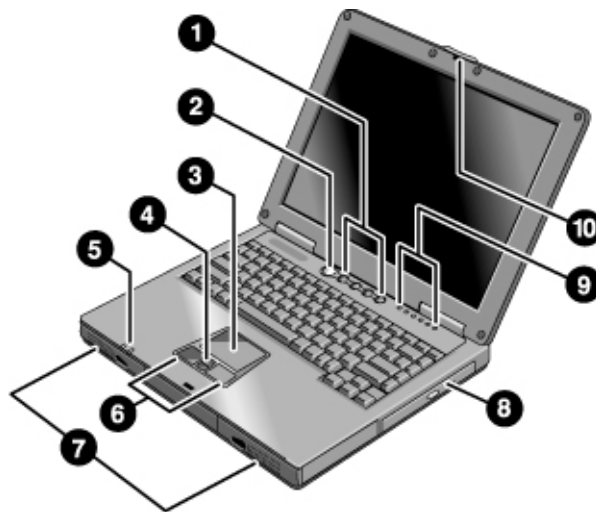

- |   |                                            |    |                                              |
|---|--------------------------------------------|----|----------------------------------------------|
| 1 | One-Touch buttons (programmable).          | 6  | Left and right click buttons.                |
| 2 | Power button.                              | 7  | Speakers.                                    |
| 3 | Touch pad (pointing device).               | 8  | DVD, or CD-RW/DVD drive (with eject button). |
| 4 | Scroll up/down toggle.                     | 9  | Keyboard status lights (see page 15).        |
| 5 | Power/battery status lights (see page 15). | 10 | Latch.                                       |

---

Back view

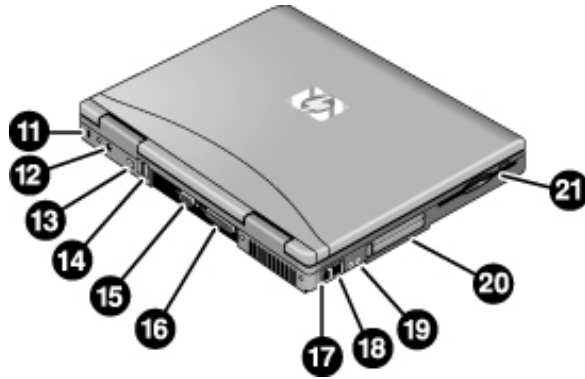

- |    |                                             |    |                                                                                  |
|----|---------------------------------------------|----|----------------------------------------------------------------------------------|
| 11 | Kensington lock slot (security connector).  | 17 | Modem port.                                                                      |
| 12 | AC adapter jack                             | 18 | LAN port and indicators (selected models).                                       |
| 13 | IEEE 1394 connector (selected models)       |    |                                                                                  |
| 14 | USB ports (2).                              | 19 | Headphone jack (colored lime green) and external microphone jack (colored pink). |
| 15 | External monitor (VGA) port (colored blue). | 20 | PC card slot and eject button.                                                   |
| 16 | Parallel port (colored burgundy).           | 21 | Floppy disk drive.                                                               |

Getting Started with Your HP Notebook  
**Identifying Parts of the Notebook**

---

Bottom view

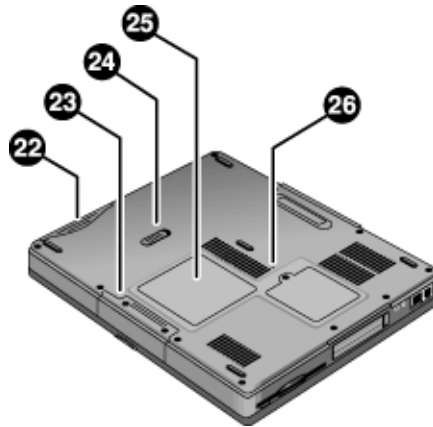

- |    |                  |    |                      |
|----|------------------|----|----------------------|
| 22 | Battery.         | 25 | RAM expansion cover. |
| 23 | Hard disk drive. | 26 | System-off switch.   |
| 24 | Battery latch.   |    |                      |

---

## Status lights

The status lights on the front of the notebook report battery and power status.



### 1. **Battery charge.**

- Green: the AC adapter is connected and the battery is fully charged.
- Amber: the AC adapter is connected and the battery is charging.
- Red: the AC adapter is connected and the battery has a fault.
- Off: the AC adapter is not connected or the battery is missing.

### 2. **Power mode.**

- Steady green: the notebook is on (even if the display is off).
- Flashing green: the notebook is on standby.
- Off: the notebook is off or in hibernation.

## Getting Started with Your HP Notebook Identifying Parts of the Notebook

The status lights above the keyboard indicate the states of the keyboard locks, as well as hard disk, floppy disk, and CD/DVD drive activity.

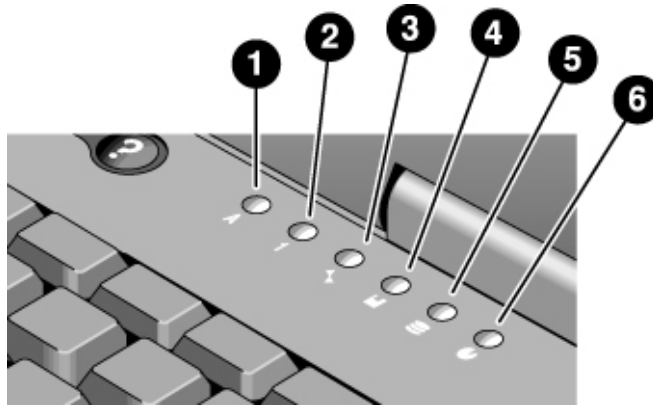

1. **Caps Lock.** Caps Lock is active.
2. **Num Lock.** Num Lock is active. (The Keypad Lock must also be on to use the embedded keypad.)
3. **Scroll Lock.** Scroll Lock is active.
4. **Floppy disk drive activity.** The notebook is accessing the floppy disk drive.
5. **Hard disk drive activity.** The notebook is accessing the hard disk drive.
6. **CD/DVD drive activity.** The notebook is accessing the CD/DVD drive.

---

## Setting Up Your Notebook

---

### WARNING

**Improper use of keyboards and other input devices has been associated with ergonomic injury. For information about reducing your risk, see “Working in Comfort” in the online HP Library, or visit our ergonomics web site, [www.hp.com/ergo](http://www.hp.com/ergo). For a summary about working with a notebook computer, see “Working in Comfort with a Notebook PC” on page 29.**

**If you are using your notebook as your primary computer, or using it for extended periods, you should use it with a full-size keyboard, monitor, and mouse. This can reduce the risk of ergonomic injury. See “Working in Comfort” in the online HP Library.**

---

When you set up your notebook for the first time, you'll need to install and charge the battery, connect the AC adapter and a phone line, turn on the notebook, run the Windows setup program, and register the notebook.

"Your notebook comes with an AC adapter rated at 75W. Older HP AC adapters were only rated at 60W. To ensure that your computer operates properly, please be sure that you use only the adapter supplied with this notebook. If it is necessary to replace your adapter, hp recommends you verify that you use only those adapters specifically approved for this model computer."

---

### Step 1: Install the battery

---

### WARNING

**Do not mutilate or puncture batteries. Do not dispose of batteries in fire, or they can burst or explode, releasing hazardous chemicals. Rechargeable batteries must be recycled or disposed of properly.**

---

Your notebook is shipped with the battery installed. If the battery has been removed, install it as follows:

## Getting Started with Your HP Notebook Setting Up Your Notebook

- Insert the battery into the battery compartment, then press it in until it clicks into place.

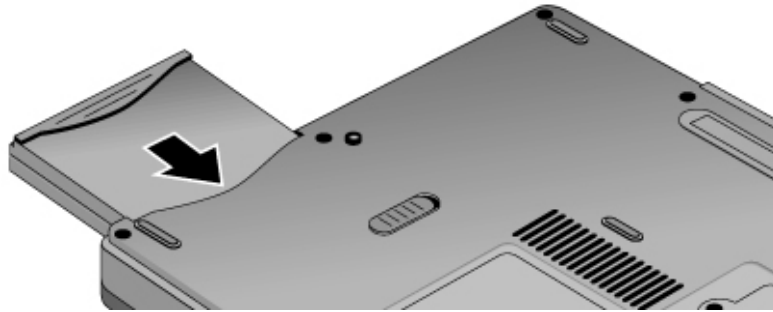

Once you have installed the battery, you can connect the AC adapter to the notebook and charge the battery while you work.

### To remove the battery

- Slide the battery's release latch, then pull the battery out of its compartment.

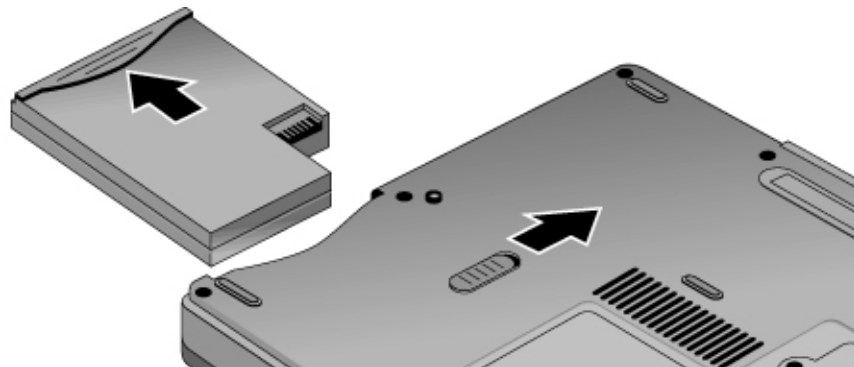

---

### WARNING

---

**Do not mutilate, puncture, or dispose of batteries in fire. A battery can burst or explode, releasing hazardous chemicals. A rechargeable battery must be recycled or disposed of properly.**

---

## Step 2: Connect AC power

---

### CAUTION

Use only the 75-watt HP AC adapter included with your notebook, or another HP approved adapter. Using any other AC adapter can damage the notebook, and may void your warranty—see the warranty statement on page 58.

The pre-installed electronic online manual on your notebook may refer to the use of a 60-watt AC adapter designed for an earlier released product. A 60-watt AC adapter should not be used with this current product.

---

- Plug the AC adapter into the power source (the adapter's LED lights), then connect it to the AC adapter jack on the back of the notebook. The notebook's battery then begins charging.



While the battery is charging, you can continue with step 3.

### Step 3: Connect a phone line

Your notebook includes a built-in modem. If you prefer, you can instead use a PC card modem or an external modem to connect a phone line.

1. Make sure the telephone line is an analog line. You must not use a digital line. (Many office and some home lines are digital.)
2. Plug the telephone cord into the notebook's modem jack, or into a PC card or external modem. Make sure the cord clicks into place.

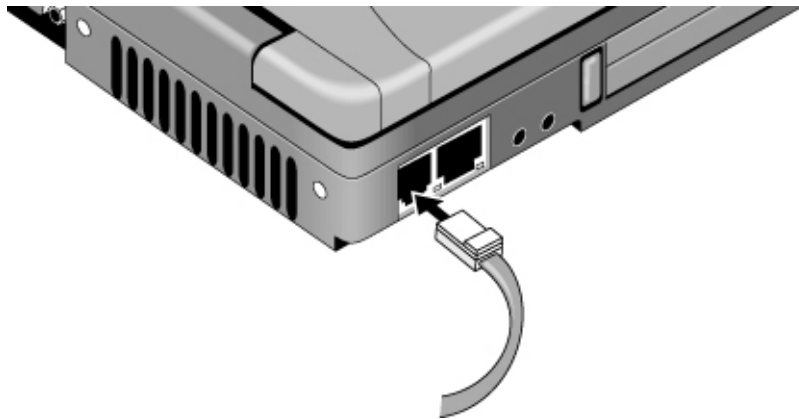

3. Plug the other end of the cord into a telephone jack. If the plug on the phone cord doesn't fit your telephone jack, you may need to use an adapter.

For details about using the modem, see the section "Using the Modem" in the online *Reference Guide*.

---

## Step 4: Turn on the notebook

- Press the power button located above the keyboard. The notebook then boots up, and Windows starts automatically.

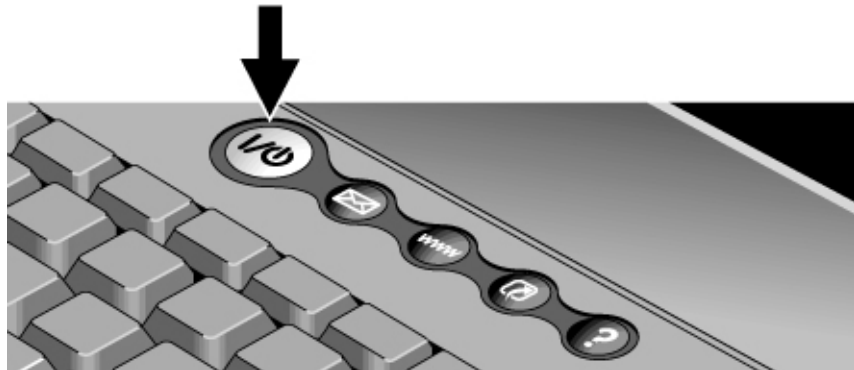

---

### Hint

If your notebook does not turn on when using only its battery, the battery may be discharged. Connect the AC adapter and press the power button again. Leave the AC adapter connected for at least an hour.

---

## Step 5: Set up Windows

Your notebook has Microsoft Windows XP preinstalled on its hard disk drive. The first time you turn on your notebook, a Windows setup program runs automatically.

1. Follow the setup program's instructions as they appear on the screen.
2. Check the modem's country or region settings: click Start, Control Panel, Printers and Other Hardware, Phone and Modem Options. On the Dialing Rules tab, verify the settings for your location, or create a new location.

---

### Note

If you need the Windows XP Product ID code, you'll find it on the bottom of the notebook.

## Step 6: Register your notebook

Be sure to register your notebook. Registering is free and fast, and ensures that you will receive quicker, more personalized support. The information you provide during registration is used to provide you with better products and services.

Registering your notebook does the following:

- Records your ownership of the notebook with Hewlett-Packard and provides access to service, support, and information.
- Records your ownership of the Windows XP operating system with Microsoft.

You can register while setting up Windows, or later in any of three ways: by modem, by phone, or by fax. For some countries and models, an HP notebook registration icon is available on the desktop.

### **By modem**

If you decide not to register while setting up Windows, you can register later by modem by double-clicking the HP Notebook Registration icon on the desktop. Make sure the phone line is connected and follow the onscreen instructions. The icon disappears after you register.

### **By phone**

You can register your notebook by calling your HP Customer Care Center—see “To contact HP for support or service” on page 54.

### **By fax**

If you have a printer connected to your notebook, you can print a registration form that you can fax to HP. Double-click the HP Notebook Registration icon on the desktop, and print the registration form. You will find the fax number on the form.

---

## To connect to the Internet

You can use your notebook’s modem or LAN port (selected models) to connect to the Internet. For details, see “Modem and Network Connections” in the online *Reference Guide*.

---

## Basic Operation

---

## Operating Your Notebook

You can start and stop your notebook using its power button. However, at certain times you may want to use other methods to start or stop the notebook—depending on power considerations, types of active connections, and start-up time.

For details about using the One-Touch buttons and other special features, plus information on caring for and protecting your notebook, see “Operating Your Notebook” in the online *Reference Guide*.

---

**Note**

This manual describes your notebook in its original factory configuration, with all settings at their default values.

---

### To turn the notebook on and off

| Power mode                                                                                                                                                                                                                         | To enter this mode                                                                                                                                              | To turn on again                                       |
|------------------------------------------------------------------------------------------------------------------------------------------------------------------------------------------------------------------------------------|-----------------------------------------------------------------------------------------------------------------------------------------------------------------|--------------------------------------------------------|
| <b>On</b><br>Power mode status light is green.                                                                                                                                                                                     | Press the power button.                                                                                                                                         |                                                        |
| <b>Standby</b><br>Saves significant power.<br>Turns off the display and other components.<br>Maintains the current session in RAM.<br>Restarts quickly.<br>Restores network connections.<br>Power mode status light flashes green. | Click Start, Turn Off Computer, Stand By.<br>–or–<br>Press the power button.<br>–or–<br>Allow timeout.                                                          | Press the power button to quickly resume your session. |
| <b>Hibernation</b><br>Saves maximum power.<br>Saves the current session to disk, then turns off.<br>Restores network connections.<br>Power mode status light is off.                                                               | Click Start, Turn Off Computer, then press and hold Shift and click Hibernate.<br>–or–<br>Allow timeout.                                                        | Press the power button to resume your session.         |
| <b>Turn off</b><br>Saves maximum power.<br>Turns off without saving the current session.<br>At startup, resets everything, starts a new session, and restores network connections.<br>Power mode status light is off.              | Click Start, Turn Off Computer, Turn Off.<br>–or–<br>Press and hold the power button for four seconds. (Do this only if the Start menu procedure doesn't work.) | Press the power button to start with a new session.    |

You can customize how these power modes work, and the ways in which you can put the notebook into them. See the section titled “Batteries and Power Management” in the online *Reference Guide*.

---

## To reset your notebook

Occasionally, you may find that Windows or the notebook has stopped responding. If this happens, try the following in the order listed.

- If possible, turn off the notebook from Windows: click Start, Turn Off Computer, Restart (or Turn Off).
- Press Ctrl+Alt+Del, then click Shut Down, Restart (or Turn Off).
- Press and hold the power button for four seconds, then release it.
- If the notebook still does not turn off, use a straightened paper clip to press the system-off switch on the bottom of the notebook, near the RAM access door.

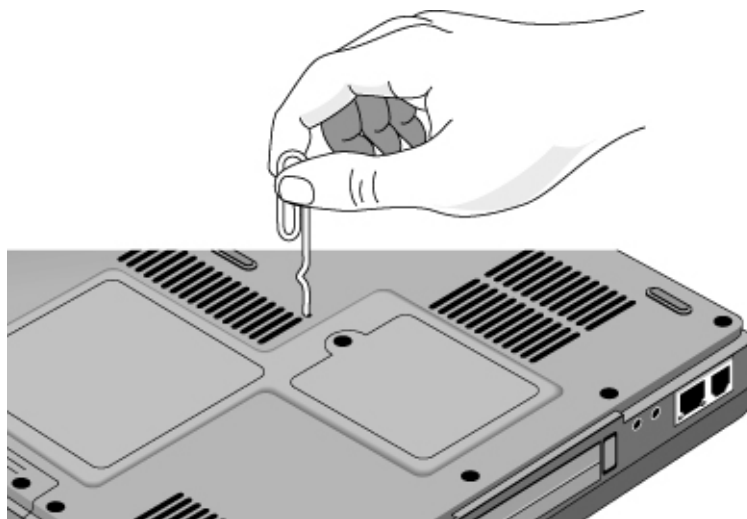

After the notebook turns off, press the power button to turn it on again.

## To change the boot device

The notebook normally boots from its internal hard disk. You can also boot the notebook from a floppy disk drive, the CD/DVD drive, or a local area network (LAN).

1. Restart the notebook: click Start, Turn Off Computer, Restart.
2. When the HP logo appears, press Esc to display the Boot menu.
3. Use the arrow keys to select the boot device, and press Enter.

If you want to boot from a specific device whenever it is present, change the boot order using the BIOS configuration utility—see “To run the BIOS configuration utility” on page 48.

---

## To use the touch pad

Your notebook includes a built-in touch pad, scroll toggle switch, and click buttons.

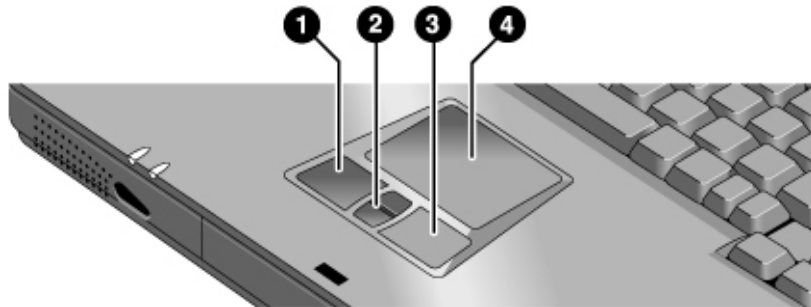

1. Left click button—works like the left button on a standard mouse.
2. Scroll up/down toggle—scrolls the contents of a window.
3. Right click button—works like the right button on a standard mouse.
4. Touch pad—pressure-sensitive pointing and clicking device.

**Moving and selecting using the touch pad and click buttons**

- To move the pointer, move your thumb or finger across the touch pad.
- Use the click buttons—which function like the left and right buttons on a mouse—to make your selection. You can also tap on the touch pad instead of clicking a button.
- To open an application or document, move the pointer over the icon, then either press the left click button twice rapidly (double-click), or tap twice quickly on the touch pad.
- To make a menu selection, move the pointer to the item and click the left click button.
- To open the shortcut menu for an item, move the pointer over the item and click the right click button.
- To drag an item, move the pointer over the item. Press and hold the left click button while you move the pointer to the new location, then release the button.
- To scroll up or down, press the upper or lower portion of the scroll toggle.

You can customize the operation of many of these devices: you can change the click button actions, double-click speed, pointer speed, and more: click Start, Control Panel, Printers and Other Hardware, Mouse, or double-click the touch pad icon in the taskbar.

## To use the Fn hot keys



The combination of the Fn key plus another key creates a *hot key*—a shortcut key sequence—for various system controls.

- To use a hot key, press *and hold* Fn, press the appropriate second key, then release both keys.

| Hot key      | Does this                                                                                   |
|--------------|---------------------------------------------------------------------------------------------|
| Fn+F1        | Decreases the display's brightness.                                                         |
| Fn+F2        | Increases the display's brightness.                                                         |
| Fn+F5        | Switches among the built-in display, an external display, and simultaneous display on both. |
| Fn+F8        | Toggles the embedded numeric keypad on and off.                                             |
| Fn+F9        | Toggles Num Lock on and off.                                                                |
| Fn+F10       | Toggles Scroll Lock on and off (except on an external keyboard).                            |
| Fn+Home      | Toggles the sound on and off (mutes sound).                                                 |
| Fn+Page Up   | Increases sound volume (except on an external keyboard).                                    |
| Fn+Page Down | Decreases sound volume (except on an external keyboard).                                    |

External keyboards do not support Fn hot keys.

---

## Working in Comfort with a Notebook PC

You can use your HP notebook computer virtually anywhere, anytime. The following recommendations should help you work more comfortably.

Note that if you are using your portable computer as your primary computer or for extended periods, you should use it with a full-size keyboard, monitor, and mouse. This will give your notebook the adjustability and comfort features of a desktop unit. More information on how to prepare your workspace environment and set up your HP equipment is available in *Working in Comfort*, which is preloaded on the hard disk in the HP Library (click Start, Help and Support, HP Library) and available on the *Recovery CDs* in \hp\library—as well as at [www.hp.com/ergo](http://www.hp.com/ergo).

---

### WARNING

---

**Improper use of keyboards and other input devices has been associated with ergonomic injury. For more information about reducing your risk, visit our ergonomics web site or see *Working in Comfort* in the online HP Library.**

#### Your mobile work environment

- Use a chair that provides good support for your lower back. If an adjustable chair is not available, you can use a pillow or rolled-up towel to provide lower back support.
- Try to keep your thighs parallel to the floor and your feet flat on the floor. In a mobile environment, you can do this by using a phone book or briefcase to support your feet.
- Adjust the height of either your work surface or chair to keep your arms in a neutral position. Your arms should be relaxed and loose, elbows at your sides, with the forearms and hands parallel with the floor.
- Position your notebook's display to minimize glare and reflection. For example, on an airplane, lower the window shade; or in a hotel room, draw the curtains. You should also maintain a comfortable viewing distance—approximately 40 to 60 cm (16 to 24 inches). Adjust the angle of your display to help keep your head angled slightly downward in a comfortable position.

## Basic Operation

### **Working in Comfort with a Notebook PC**

#### **Using your notebook computer**

- Position the notebook so your wrists and hands are in a neutral position. Your wrists should be as straight as possible and should not have to bend sideways or more than 10 degrees up or down. Your HP notebook computer has a built-in palm rest, which is ideal for this purpose.
- Try to type as lightly as possible. The notebook's keyboard requires little force to activate.
- Take frequent, short rest breaks—this is especially important in a mobile computing environment.
- Portable computers weigh between approximately 1.5 and 4 kilograms (approximately 3 to 8 pounds). When traveling, be sure to carry your notebook computer properly to minimize strain on your body. Shift the bag containing your notebook equipment frequently between your left and right hands and shoulders.

---

## Batteries and Power Management

## Using Battery Power

For information about how your notebook regulates its power consumption, and how you can manually reduce power consumption and extend the life of the notebook's battery, see the chapter titled "Batteries and Power Management" in the online *Reference Guide*.

---

### To check battery status

#### **From the battery charge light**

The battery charge light on the front of the notebook shows whether the notebook's battery is charging or fully charged—see "Status lights" on page 15.

#### **From the Windows taskbar**

The Windows taskbar includes a power icon that provides detailed battery status information (see Windows Help and Support for details). The icon looks like a battery when AC is not connected.

- Place the pointer over the power icon to display the remaining battery charge. This value is shown as either a percentage of charge remaining, or as time remaining.
- Double-click the power icon to open the Power Meter window.
- Click the power icon to display a menu of the available power schemes.
- Right-click the power icon to view the options for displaying power information.

#### **From the Windows Control Panel**

- Click Start, Control Panel, Performance and Maintenance, Power Options, then click the Power Meter tab to see battery status. The Alarms and Advanced tabs provide additional power-information options.

#### **On the battery**

1. Remove the battery from the notebook—see page 17.
2. Press the contact pad on the side of the battery. The number of lights that turn on indicates the remaining charge: each light represents 20% of a full charge.

---

## To respond to a low-battery warning

The notebook automatically alerts you when battery power drops to a critically low level. If you do not restore power within a short time, the system goes into hibernation.

Once the notebook enters hibernation in this way, you won't be able to turn it on again until you restore power by doing one of the following:

- Connect the AC adapter (see page 19).
- Replace the battery with one that is charged (see page 17).

---

### Note

If you connect the AC adapter, you can continue to work while your battery recharges.

---

## To recharge the battery

---

### CAUTION

**The AC adapter is normally warm whenever plugged into an AC outlet. The notebook's battery is normally warm while recharging. Do not recharge the notebook in a briefcase or other confined space, or its battery could overheat.**

- To recharge the battery, connect the AC adapter to the notebook.

To get the longest operating time, wait until the battery's charge is below 20% before recharging, then charge it fully (100%). You can continue working while the battery charges.



---

## Add-On Devices

---

## Installing Additional RAM

Your notebook has no built-in memory (RAM), but has two slots for removable RAM modules in a compartment on the bottom of the unit. (One of these slots contains a module installed at the factory). You can use these slots to expand your unit's RAM. Use HP PC133 SDRAM modules only, or your notebook will not boot up.

You'll need a small (#0) Phillips screwdriver for these procedures.

---

### To install a RAM expansion module

To increase your notebook's RAM, you can install a RAM module in the expansion slot on the bottom of the notebook. Use HP PC133 SDRAM modules only.

---

#### CAUTION

**Your notebook's chips are extremely sensitive to static electricity, and can be permanently damaged by it. Handle the RAM module only by its edges. Before installing the memory module, discharge your body's static electricity by touching the metal shielding around the connectors on the rear of the notebook.**

1. Turn off the notebook: click Start, Turn Off Computer, Turn Off.
2. **Important:** unplug the AC adapter (if present) and remove the notebook's battery.
3. On the bottom of the notebook, loosen the screw holding the RAM cover (the cover retains the screw), and remove the cover.
4. Insert the RAM module into the connector at about a 30° angle until it's fully inserted. Then press down on both sides of the module until it latches.

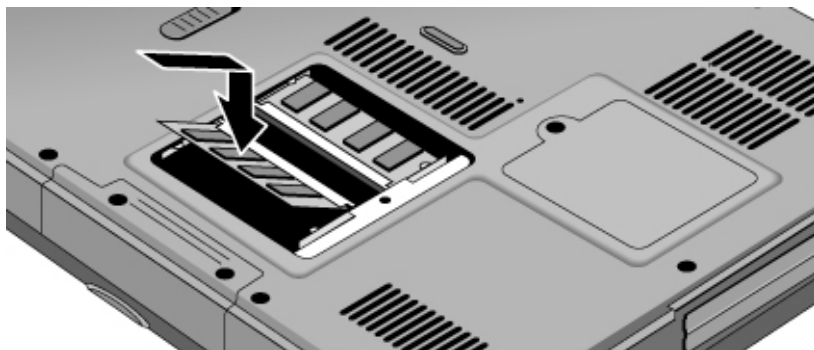

5. Replace the RAM cover.

6. Reinstall the notebook's battery.

---

## Replacing the Hard Disk Drive

---

### To replace the hard disk drive

You'll need a small (#0) Phillips screwdriver for this procedure.

1. Unplug the AC adapter, if present, and remove the notebook's battery.
2. Remove both hard drive retaining screws from the bottom of the notebook.

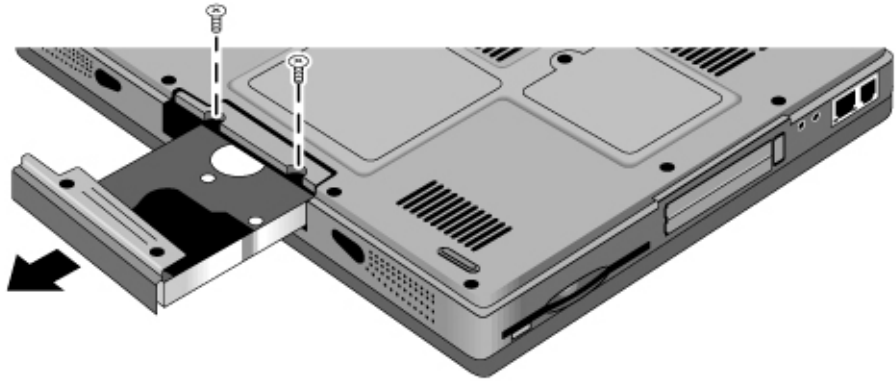

3. Pull the hard drive out of the notebook.
4. Carefully slide the new drive into the hard drive compartment. Press firmly to make sure its connector seats properly.
5. Reinstall the hard drive retaining screws.

---

#### **Important**

---

If you are installing a new hard disk drive, create a Utility partition on the drive before loading any software—see “To recover the factory installation of your hard disk” on page 50.

To install the holder on a new hard disk drive or prepare a new hard disk for use, see “Replacing the Hard Disk Drive” in the online *Reference Guide*.

---

## Troubleshooting and Maintenance

---

## Troubleshooting Techniques

This section contains solutions to a few basic problems you might experience while using your notebook. Try the solutions one at a time, in the order in which they are presented.

Here are some other sources of information for troubleshooting:

- See the troubleshooting chapter in the online *Reference Guide* for a more complete list of troubleshooting suggestions.
- Open the HP web-based troubleshooting tool: click Start, Help and Support, HP Instant Support. Search or browse the troubleshooting database for the information related to your problem.
- Click Start, Help and Support, Fixing a Problem, and use the Windows troubleshooters.
- See the Microsoft Windows manual shipped with your notebook.
- For updated information, see the HP Notes in the online HP Library (click Start, All Programs, HP Library, HP Notes) or on the *Recovery CDs* in \hp\library.
- Find technical tips and software updates for your notebook at the HP Business Support web site ([www.hp.com/go/bizsupport](http://www.hp.com/go/bizsupport)).
- Test your notebook by running the e-DiagTools test program—see “Testing the Hardware” on page 46.
- Contact your dealer or Hewlett-Packard—see “To contact HP for support or service” on page 54. Please have your notebook with you when you call.

---

### Display problems

#### **If the notebook is on, but the screen is blank**

- Move the mouse or tap the touch pad. This will wake the display if it is off.
- Try pressing Fn+F2 to increase the brightness.
- Press Fn+F5 in case the internal display was disabled. (Do this three times to return to the state you started from.)
- If the notebook is cold, allow it to warm up.

**If the screen is difficult to read**

- Check whether the display resolution is set to its default of 1024×768: click Start, Control Panel, Appearance and Themes, Display, Settings.

## Hard disk drive problems

### **If the notebook's hard drive doesn't spin**

- Make sure the notebook has power. If necessary, connect the AC adapter, and make sure it is plugged securely into a power source and into the back of the notebook.

### **If the hard disk makes a buzzing or whining noise**

- Back up the drive immediately.
- See whether the noise is coming from elsewhere, such as the fan or floppy disk drive.

### **If files are corrupted**

- Check the hard disk: open My Computer, select the disk you want to scan, then click File, Properties, and use the Tools tab.
- Test the hard disk drive with the e-DiagTools diagnostics—see “Testing the Hardware” on page 46.
- If necessary, format the hard disk and reinstall the original factory software—see “To recover the factory installation of your hard disk” on page 50.

### **The hard drive's reported capacity is less than its actual size**

- The hard disk drive is preconfigured to allocate some space to diagnostic software, which is used for support and service of your notebook. This part of the hard drive is unavailable for other uses, and so is not included in the capacity of the hard drive as reported by Windows (My Computer, Properties).

---

## Keyboard, touch pad, and mouse problems

### **If the touch pad is difficult to control**

- Customize the touch pad by modifying Mouse properties: click Start, Control Panel, Printers and Other Hardware, Mouse.

### **If the pointing devices don't work**

- Don't use the touch pad while the notebook is starting up or resuming from standby or hibernation. If this happens, try the following:
  - Press any key on the keyboard.
  - Put the notebook on standby, then resume operation.
- Restart the notebook: click Start, Turn Off Computer, Restart.
- Test the keyboard and pointing devices with the e-DiagTools diagnostics—see “Testing the Hardware” on page 46.

### **If a special feature on a USB mouse doesn't work**

- Make sure you installed any drivers included with the mouse.
- Restart the notebook, so that it will detect the mouse.

---

## Performance problems

For best performance with Windows XP, your notebook should have at least 128 MB of memory (RAM).

### **If the notebook pauses or runs sluggishly**

- Press Ctrl+Alt+Del to see if an application is not responding.
- Restart the notebook.
- Certain background operations (such as virus-scanning software) can affect performance and response time.
- Some file browsers respond slowly while processing graphics or waiting for broken network connections to time out.
- If the notebook's hard disk drive frequently runs (as indicated by the hard drive status light above the keyboard) while the notebook appears to be paused or running slowly, Windows is likely spending excess time writing to its swap file on the notebook's hard disk. If this occurs frequently, consider installing additional memory.
- Check the amount of available free disk space. Delete temporary and unneeded files.

### **If the notebook stops responding**

- Press Ctrl+Alt+Del to end any application that is not responding.

## Troubleshooting and Maintenance

### Troubleshooting Techniques

- Reset the notebook—see “To reset your notebook” on page 25.
- 

## Power and battery problems

### **If the notebook turns off immediately after it turns on**

- Battery power is probably extremely low. Connect the AC adapter or insert a newly charged battery.

### **If the notebook keeps beeping**

- The notebook beeps repeatedly when the battery is low (you can set this option in Power Options in Control Panel). Save your work immediately, turn off the notebook immediately, and insert a charged battery or connect the AC adapter.

### **If the battery doesn't charge**

- Make sure the AC adapter is securely connected to the power source and the notebook, and that the light on the adapter is on.
- If you're using a power strip, remove the AC adapter from the power strip and plug it directly into a wall outlet.
- Make sure the battery is properly installed and locked in place.
- Move the notebook away from any nearby heat source. Unplug the AC adapter and allow the battery to cool down. If the battery gets too hot, it will not charge properly.
- If available, try another battery and AC adapter.

### **If the notebook has a short operating time**

- If you are running an application that has an automatic save feature (such as Microsoft Word), disable this feature or increase the specified save time to reduce hard disk access.
- If the operating time has gradually become shorter and the battery is more than a year or two old, you may need to replace the battery.
- Heavy modem use or PC card use can affect battery operating time.
- The battery gauge may need to be calibrated. Restart the notebook, press F6 when the HP logo appears, and follow the instructions that appear onscreen. This process calibrates the battery, and requires four to five hours to complete. You cannot use the notebook during this time.

## Startup problems

### **If the notebook doesn't respond when you turn it on**

- Don't use the touch pad while the notebook is starting up or resuming from standby or hibernation.
- Connect the AC adapter.
- Reset the notebook by using a pin or straightened paper clip to press the system-off switch on the bottom of the notebook. Then press the power button to turn the notebook on.
- If the notebook still doesn't respond, remove the battery and AC adapter, and remove any PC card. Then reset the notebook using the system-off switch on the bottom of the notebook, replace the battery and connect the AC adapter, and turn on the notebook by pressing the power button.
- If you still get no response, call HP for assistance.

### **If the notebook won't boot from battery power**

- Make sure the battery is properly inserted and fully charged. Check the battery's charge by clicking the power icon in the taskbar, or using Power Options in Control Panel.
- If available, try another battery.

### **If the notebook won't boot from the floppy disk drive**

- Make sure the floppy disk is bootable.
- Make sure the floppy disk drive is selected as the boot device—see “To change the boot device” on page 26.

---

## Testing the Hardware

The e-DiagTools hardware diagnostic program included with your notebook provides two levels of testing:

- Automated testing using the basic hardware test.
- Advanced testing using individual hardware tests.

The tests are designed to run after the system reboots. This ensures that the notebook will be in a predictable state, so the diagnostic program can properly test the hardware components. The tests are nondestructive and are intended to preserve the state of the notebook. The notebook reboots when you exit e-DiagTools.

---

### To run the e-DiagTools diagnostic tests

1. Restart the notebook: click Start, Turn Off Computer, Restart.
2. When the HP logo appears, press F10 to start the diagnostic test.
3. When the menu appears, press Enter to run e-DiagTools.

The first time you run the program, you will be prompted to select the language for the program.

4. Follow the prompts to run e-DiagTools.
5. When the Configuration Description appears, verify the list of detected hardware.
6. **Run the basic test.** Press F2 to start the basic hardware test. The results appear when the test is complete.
7. If you intend to exit without running the advanced tests, press F4 and then F7 to view the Support Ticket. Press Esc and then F3 to exit.
8. **Optional: run the advanced tests.** Press F2 to open the advanced test screen.

9. Select and run the appropriate tests using the following keys. Tests are listed only for detected hardware.

|             |                                                 |
|-------------|-------------------------------------------------|
| Enter       | Runs the highlighted test.                      |
| F5 or Space | Marks or unmarks the highlighted test.          |
| F6          | Marks or unmarks all tests in the current menu. |
| F7          | Marks or unmarks all tests in all menus.        |
| F10         | Runs all marked tests.                          |

10. **Save the Support Ticket.** Press T to update and display a Support Ticket containing system and test information. Press Esc to exit.
11. When you have finished running advanced tests, press Esc to exit.
12. **Optional:** to save the Support Ticket to a floppy disk, press F7, then Alt+C.
13. **Exit.** Press F3 and then any key to exit and reboot.
14. **Optional: open the Support Ticket.** In Windows, click Start, All Programs, HP e-DiagTools, e-DiagTools for Windows.
15. Click View to display the Support Ticket.
16. To add information about your problem, click Comments and type the information, then click OK.

To save or print the Support Ticket, click Save As or Print.

To e-mail the Support Ticket to your support agent, click e-Mail. The first time you make an e-mail connection from this program, click Change Settings in the Connect window and enter the settings recommended by your support agent.

e-DiagTools for Windows can also update the version of e-DiagTools on your notebook's hard disk. In e-DiagTools for Windows, use the e-DiagTools menu.

If you have trouble running e-DiagTools from the hard disk, you can also run it from the *Recovery CDs*. Boot from disk 1 and select the diagnostics option.

---

## Configuring Your Notebook

---

---

### To run the BIOS configuration utility

The BIOS (Basic Input and Output System) configuration utility enables you to make changes to the notebook's system configuration and tailor its operation to your needs.

The settings in the BIOS configuration utility control the notebook's hardware, and so have a fundamental effect on how the notebook operates.

#### **To run the BIOS configuration utility**

1. Restart the notebook: click Start, Turn Off Computer, Restart.
2. When you see the HP logo, press F2 to enter the BIOS configuration utility.
3. Select the options you want—refer to the listing on the next page.
4. When you finish making changes, press F10 (or select Exit, Save and Reboot).
5. Press Enter to confirm and restart the notebook.

The pointing devices are not active in the BIOS configuration utility, so you'll need to use the keyboard to navigate:

- Press the left and right arrow keys to move from one menu to another.
- Press the up and down arrow keys to move among parameters in a menu.
- Press Enter to open the dialog for the current parameter, or to select the parameter.
- Press Tab or the left and right arrow keys to move among selections in a dialog.
- Press the up and down arrow keys to changes the values for the setting.
- Press Enter to close the dialog and accept the settings.

The following tables describe the settings for the notebook's initial BIOS release. If your BIOS version is different, some settings may differ from those shown, or may be absent.

| <b>Startup Menu</b> |                                                                                                                                                                                                                                                                                                                           | <b>Default</b>                                                                                                                        |
|---------------------|---------------------------------------------------------------------------------------------------------------------------------------------------------------------------------------------------------------------------------------------------------------------------------------------------------------------------|---------------------------------------------------------------------------------------------------------------------------------------|
| Date and Time       | Sets the date using mm/dd/yyyy format and the time using 24-hour format. Value set takes effect immediately.                                                                                                                                                                                                              |                                                                                                                                       |
| Boot Device         | Shows the order of boot devices, with "+" indicating a device category. Move the entries to change the order. If the notebook has more than one device in a category, you can select the one scanned. Internal LAN appears in the list only if a built-in LAN is present—it provides diskless boot from a network server. | <ol style="list-style-type: none"> <li>1. Hard Disk</li> <li>2. CD-ROM/DVD</li> <li>3. Diskette A</li> <li>4. Internal LAN</li> </ol> |

| <b>Exit Menu</b> |                                                                                                              | <b>Default</b> |
|------------------|--------------------------------------------------------------------------------------------------------------|----------------|
| Save and Reboot  | Saves changes, then exits and reboots.                                                                       |                |
| Exit (No Save)   | Discards any changes made since last save, then exits and reboots. Does not affect date or time changes.     |                |
| Default Settings | Restores default settings and stays in the BIOS configuration utility. Does not affect date or time changes. |                |

---

## Reinstalling and Updating Software

You can use the *Recovery CDs* provided with your notebook to recover its original factory software.

The *Recovery CDs* also provide Windows drivers specific to your notebook that you can use to configure a custom system. You can find drivers in these locations:

- On your notebook's hard drive under C:\hp\drivers.
- On the *Recovery CDs* under \hp\drivers.
- On the HP Business Support web site ([www.hp.com/go/bizsupport](http://www.hp.com/go/bizsupport)). This web site contains the latest updates of software drivers for different operating systems.

---

### To recover the factory installation of your hard disk

You can use your notebook's *Recovery CDs* to reinstall the notebook's original factory software. You can also use this process to create a larger Utility partition on your hard disk, or to create a Utility partition on a new hard disk. (The hidden Utility partition contains the e-DiagTools diagnostic tests and stores hibernation data for operating systems that don't provide hibernation.)

---

#### CAUTION

**This procedure formats the notebook's hard disk drive and erases all data on the disk. After performing this procedure, you'll need to reinstall your applications.**

**Do not interrupt this process or disconnect the AC adapter until the process is complete.**

1. **Important:** back up all data from your hard disk. The following steps delete all data from the disk.
2. Connect the AC adapter to the notebook.
3. Insert the *Recovery CD* (disk 1) into the notebook's CD/DVD drive. If the notebook is turned off, use a pin or straightened paper clip to press the release switch on the drive door to open it.

4. Turn on or restart the notebook. If the notebook is on, click Start, Turn Off Computer, Restart.
5. When the HP logo appears, press Esc to display the Boot menu.
6. Use the arrow keys to select the CD-ROM/DVD drive as the boot device, and press Enter.
7. When the *Recovery CD* dialog box appears, follow the displayed instructions. If prompted, accept the recommended partition size. If you install the factory software, the recovery process can take up to 15 minutes.

If you want to create the Utility partition without installing the factory software, click Advanced and select not to install the operating system.

If your hard disk is partitioned into several drives, you can install the factory software on drive C without affecting other drives. Click Advanced and select to restore only the C partition.

8. **Important:** when prompted to reboot the notebook, press Ctrl+Alt+Del and follow any instructions that appear.

You can find more details about recovering the factory installation of Windows on the *Recovery CDs*: the file readme.txt is in the root directory of each disk.



---

## HP Service and Support

---

## Getting Assistance for Your Notebook

---

### To get help from HP Instant Support

To get online technical support for your notebook, click Start, Help and Support (or All Programs), HP Instant Support.

---

### To get help from the web

HP has several web sites on the Internet dedicated to providing information about HP notebook computers:

- **HP Business Support web site.** Get e-mail and telephone support information, technical information, and software updates: [www.hp.com/go/bizsupport](http://www.hp.com/go/bizsupport)
- **HP Notebook computer web site.** Get the latest information about technical support, plus information about warranty and support programs: [www.hp.com/notebooks](http://www.hp.com/notebooks)

---

### To contact HP for support or service

HP Customer Care Centers will assist you free of charge during the term of the warranty (you are responsible for the telephone charges).

**During the free assistance period, HP will assist with questions on these topics:**

- Applications and operating systems included with your notebook.
- HP-described operation environments and conditions.
- HP accessories, HP upgrades, and basic operation and troubleshooting.

**HP will not be able to help with questions on these topics:**

- Non-HP hardware, software, operating systems, or usage not intended for nor included (by HP) with the product.
- How to repair the product yourself.
- Product development or custom installations.

- Consulting.

To contact the HP Customer Care Center, visit the HP Business Support web site ([www.hp.com/go/bizsupport](http://www.hp.com/go/bizsupport)) under “Contact HP.” You can find information for contacting the Customer Care Center by e-mail, as well as a current list of phone numbers. If your HP notebook product is not normally sold by HP in the country of use, you must call a Customer Care Center that supports your notebook model. Currently, service and support assistance is provided only in the following countries:

**Pavilion Notebooks (limited to the following)**

- United States: +1 (970) 635-1000

For best service, have as much of the following information as possible when you call.

- Your notebook’s model, serial number, and operating system.
- Any messages displayed when the problem occurred.
- Were there any changes to the notebook, software, related hardware, or accessories before this occurred?
- Can you re-create the problem?

## To receive repair service

If the HP notebook product is not normally sold by HP in the country of use, it must be returned for service to a country in which it is sold and supported.

**If your notebook is under warranty.** To receive warranty repair service for your Pavilion Series notebook, contact the HP Customer Care Center—see “To contact HP for support or service” on page 54. The support technician will help qualify your unit for warranty repair based on the warranty applicable to your unit and original purchase date, and will provide you with repair processes. Warranty service may include the cost of shipping, handling, duties, taxes, freight, or fees to or from the service location.

---

**Note**

HP Pavilion notebooks have regional support and service in selected countries. Currently, HP Pavilion notebook PCs are supported only in the country in which they are purchased and marketed. If you are outside the country of purchase, you must cover the cost of shipping your notebook to the appropriate HP authorized repair site.

If you are uncertain about the support, please contact our Customer Care Center—see “To contact HP for support or service” on page 54.

---

**If your notebook is no longer under warranty.** Contact the HP Customer Care Center—see page 54 or an HP-Authorized reseller. The support provider will provide details about repair charges and processes.

---

**Note**

You are financially responsible for any repairs to your notebook that are not covered by the HP warranty—see the warranty statement on page 58. This includes any repairs required if you damage your notebook—for example, by spilling liquid onto it, dropping it, or breaking the display.

In addition, most DVD drives let you change the region code only a limited number of times (usually no more than four) to allow you to set the proper region code for your area. Please note that when you reach this limit, your last change to the region code will be hard-coded on the DVD drive, and will be permanent. **Your HP warranty does *not* cover the expense of correcting this situation.**

---

---

## To prepare your notebook for shipment

See “To receive repair service” on the previous page to determine if your notebook must be sent in for service. If it must, prepare it for shipment as follows.

---

**Note**

---

If you have questions about packaging requirements when returning your notebook for repair, contact HP Service and Support—see page 54. If your notebook is not packaged properly, you will be responsible for any damages that occur to it during shipping.

1. **Important. back up your hard disk drive.** The hard disk may need to be replaced or reformatted while your notebook is being repaired.
2. Hewlett-Packard cannot guarantee the return of removable components. Please remove the following before you send your notebook for service:
  - PC cards.
  - AC adapter and power cord.
  - Any removable media, such as CDs, DVDs, or floppy disks.
  - Any hardware not involved in the problem and not requested for repair.
3. When sending your notebook to Hewlett-Packard, please use the original product packaging or other substantial packaging to avoid damage to the notebook in transit. Make sure at least three inches of suitable packaging material surround the notebook.

Your notebook will be returned to you in new packaging.

---

**Note**

---

If the hard disk drive is defective, you will receive a replacement drive that is either unformatted or loaded with software for verification. You should restore the notebook’s original software using your *Recovery CDs* (see “To recover the factory installation of your hard disk” on page 50) or other recovery method.

---

## Hewlett-Packard Limited Warranty Statement

1. HP warrants to you, the end-user customer, that HP hardware, accessories, and supplies will be free from defects in materials and workmanship after the date of purchase, for the period specified in the Warranty Duration table below. HP Pavilion and Omnibook XE Series Notebooks typically come with a standard one-year warranty. Please see the Warranty Duration table for details. If HP receives notice of such defects during the warranty period, HP will, at its option, either repair or replace products which prove to be defective. Replacement products may be either new or equivalent in performance to new.
2. HP warrants to you that HP software will not fail to execute its programming instructions after the date of purchase, for the period specified in the Warranty Duration table below, due to defects in material and workmanship when properly installed and used. If HP receives notice of such defects during the warranty period, HP will replace software which does not execute its programming instructions due to such defects.
3. HP does not warrant that the operation of HP products will be uninterrupted or error free. If HP is unable, within a reasonable time, to repair or replace any product to a condition as warranted, you will be entitled to a refund of the purchase price upon prompt return of the product.
4. HP's limited warranty is valid in any country or locality where HP has a support presence for this product and where HP has marketed this product. The level of warranty service you receive may vary according to local standards. HP will not alter form, fit, or function of the product to make it operate in a country for which it was never intended to function for legal or regulatory reasons.
5. This warranty does not apply to defects resulting from (a) improper or inadequate maintenance or calibration, (b) software, interfacing, parts, or supplies not supplied by HP, (c) unauthorized modification or misuse, (d) operation outside of the published environmental specifications for the product, or (e) improper site preparation or maintenance.

6. TO THE EXTENT ALLOWED BY LOCAL LAW, THE ABOVE WARRANTIES ARE EXCLUSIVE AND NO OTHER WARRANTY OR CONDITION, WHETHER WRITTEN OR ORAL, IS EXPRESSED OR IMPLIED AND HP SPECIFICALLY DISCLAIMS ANY IMPLIED WARRANTIES OR CONDITIONS OF MERCHANTABILITY, SATISFACTORY QUALITY, AND FITNESS FOR A PARTICULAR PURPOSE. Some countries, states, or provinces do not allow limitations on the duration of an implied warranty, so the above limitation or exclusion might not apply to you. This warranty gives you specific legal rights and you might also have other rights that vary from country to country, state to state, or province to province.
7. TO THE EXTENT ALLOWED BY LOCAL LAW, THE REMEDIES IN THIS WARRANTY STATEMENT ARE YOUR SOLE AND EXCLUSIVE REMEDIES. EXCEPT AS INDICATED ABOVE, IN NO EVENT WILL HP OR ITS SUPPLIERS BE LIABLE FOR LOSS OF DATA OR FOR DIRECT, SPECIAL, INCIDENTAL, CONSEQUENTIAL (INCLUDING LOST PROFIT OR DATA), OR OTHER DAMAGE, WHETHER BASED IN CONTRACT, TORT, OR OTHERWISE. Some countries, states or provinces do not allow the exclusion or limitation of incidental or consequential damages, so the above limitation or exclusion may not apply to you.

THE WARRANTY TERMS CONTAINED IN THIS STATEMENT, EXCEPT TO THE EXTENT LAWFULLY PERMITTED, DO NOT EXCLUDE, RESTRICT OR MODIFY AND ARE IN ADDITION TO THE MANDATORY STATUTORY RIGHTS APPLICABLE TO THE SALE OF THIS PRODUCT TO YOU.

| <b>Product</b>                                                | <b>Duration of Limited Warranty</b>                    |
|---------------------------------------------------------------|--------------------------------------------------------|
| HP Notebook with "1YR" or similar mark on serial-number label | 1 year, or number of years marked.                     |
| HP Notebook with "90D" or similar mark on serial-number label | 90 days or number of days marked.                      |
| HP Notebook accessories and batteries                         | 1 year.                                                |
| Non-HP accessories,<br>Non-HP "Distributed by HP" accessories | Not warranted by HP. Refer to manufacturer's warranty. |
| HP Software, Microsoft Software                               | 90 days.                                               |



---

## Reference Information

---

## Hardware Specifications

Because we are constantly improving our products, the specifications shown below are subject to change. For the latest specifications, go to the HP notebook web site ([www.hp.com/notebooks](http://www.hp.com/notebooks)).

---

**Note**

Technology codes identify different models of a notebook PC. These two-letter codes are found near the serial number on the bottom of the notebook.

---

Reference Information  
**Hardware Specifications**

|                                      |                                                                                                                                                                                                                                                                                                    |
|--------------------------------------|----------------------------------------------------------------------------------------------------------------------------------------------------------------------------------------------------------------------------------------------------------------------------------------------------|
| <b>Physical Attributes</b>           | 13.03 x 10.72 x 1.59 in (319 x 260 x 33 mm).<br>6.0 lbs (2.7 kg) minimum.                                                                                                                                                                                                                          |
| <b>CPU</b>                           | Technology code JA: AMD Duron and Athlon, 200-MHz FSB.                                                                                                                                                                                                                                             |
| <b>Chip Set</b>                      | Technology code JA<br>: VIA KN133 + VT8231.                                                                                                                                                                                                                                                        |
| <b>RAM</b>                           | 133-MHz SDRAM (PC133).<br>Maximum memory upgrade to 1 GB by two 512-MB SODIMM (144-pin/3.3 V) modules in two 1.25-in slots.                                                                                                                                                                        |
| <b>Mass Storage</b>                  | 9.5-mm, 2.5-in hard disk drive.<br>1.44-MB floppy disk drive.                                                                                                                                                                                                                                      |
| <b>Optical drive</b>                 | DVD-ROM, 12.7mm OR DVD/CD-RW, 12.7 mm                                                                                                                                                                                                                                                              |
| <b>Display</b>                       | 14.1 or 15.1-in XGA (1024x768) TFT LCD.                                                                                                                                                                                                                                                            |
| <b>Video chip</b>                    | Integrated AGP, 3D embedded in VIA Twister.                                                                                                                                                                                                                                                        |
| <b>Keyboard and Pointing Devices</b> | 87/88/90-key spill-proof QWERTY keyboard with 101/102 key emulation.<br>Embedded numeric keypad.<br>12 function (Fn) keys.<br>Touch pad.<br>Left and right click buttons, center scroll button.                                                                                                    |
| <b>Audio</b>                         | Two stereo speakers.<br>Color-coded jacks: headphone-out (lime green) and microphone-in (pink).                                                                                                                                                                                                    |
| <b>Power</b>                         | Rechargeable lithium-ion battery (55 W)<br>Low-battery warning.<br>Suspend/resume capability.<br>AC adapter (DC-in) jack.<br>Universal AC adapter: 100–240 Vac (50/60 Hz) input, 19 Vdc output, 75 W.                                                                                              |
| <b>I/O Ports</b>                     | 25-pin bi-directional high-speed ECP/EPP parallel (burgundy).<br>15-pin external monitor (VGA) video out port (blue).<br>Two universal serial bus (USB) ports.<br>IEEE 1394 port (selected models)<br>Built-in modem, supporting Wake up on Ring# from D3 (hot) with AC-in.                        |
| <b>Expandability</b>                 | One Type II or Type III 16-/32-bit PCMCIA slot.                                                                                                                                                                                                                                                    |
| <b>Options</b>                       | 128/256/512-MB PC133 SODIMM: 3.3 V, 144-pin, SDRAM.<br>Built-in LAN.                                                                                                                                                                                                                               |
| <b>Environment</b>                   | Operating temperature: 0 to 40 °C (32 to 104 °F).<br>Storage temperature: –20 to 65 °C (–4 to 149 °F).<br>Operating humidity: 20% (10% on some models) to 90% RH (0 to 40 °C).<br>Operating altitude: up to 3,000 m (10,000 ft) at 25 °C (77 °F).<br>Storage altitude: up to 12,000 m (40,000 ft). |

---

## Safety Information

---

### Power cords

The power cord supplied with the notebook's AC adapter should match the plug and voltage requirements for your local area. Regulatory approval for the AC adapter has been obtained using the power cord for the local area. However, if you travel to a different area or need to connect to a different outlet or voltage, you should use one of the power cords listed below. To purchase a power cord (including one for a country not listed below) or a replacement AC adapter, contact your local Hewlett-Packard dealer or Sales office. For any power cord with a fused plug, if you have to replace the fuse, be sure to install an approved fuse.

| Country/Region                                             | Rated Voltage and Current | HP Part Number |
|------------------------------------------------------------|---------------------------|----------------|
| Canada<br>Mexico<br>Philippines<br>Taiwan<br>United States | 125 Vac (3 A)             | 8120-6313      |
| Europe<br>Egypt<br>Israel<br>Saudi Arabia                  | 250 Vac (2.5 A)           | 8120-6314      |
| Hong Kong<br>Singapore<br>United Kingdom                   | 250 Vac (2.5 A)           | 8120-8699      |
| Australia<br>New Zealand                                   | 250 Vac (2.5 A)           | 8120-6312      |
| Japan                                                      | 125 Vac (3 A)             | 8120-6316      |
| India                                                      | 250 Vac (2.5 A)           | 8121-0702      |
| South Africa                                               | 250 Vac (2.5 A)           | 8120-6317      |
| Argentina                                                  | 250 Vac (2.5 A)           | 8120-8367      |
| Chile                                                      | 250 Vac (2.5 A)           | 8120-8452      |
| People's Republic of China                                 | 250 Vac (2.5 A)           | 8120-8373      |

---

## Ergonomics

---

### WARNING

**Improper use of keyboards and other input devices has been associated with ergonomic injury. For information about reducing your risk, see “Working in Comfort” in the online HP Library, or visit our ergonomics web site, [www.hp.com/ergo](http://www.hp.com/ergo).**

---

---

## Battery safety

---

### Note

Use only the battery that came with your notebook, or an HP-approved replacement—see “To buy accessories” in the online *Reference Guide*.

- To avoid risk of fire, burns, or damage to your battery, do not allow a metal object to touch the battery contacts.
- Do not disassemble the battery. There are no serviceable parts inside.
- Handle a damaged battery with extreme care. If you come in contact with the electrolyte, wash the exposed area with soap and water. If it contacts the eye, flush the eye with water for 15 minutes and seek medical attention.
- Do not expose the battery to storage temperatures above 60° C (140° F).
- Do not charge the battery if the ambient temperature exceeds 45° C (113° F).
- Replace only with the same or equivalent type battery recommended by the manufacturer. To obtain a replacement battery, contact your local dealer or HP sales office.
- Before discarding a battery, contact your local waste disposal provider regarding local restrictions on the disposal or recycling of batteries.
- Do not dispose of the battery in fire or water.
- The battery is suitable for use only with compatible HP notebook models. For more information, see “To contact HP for support or service” on page 54.

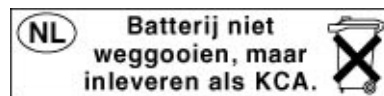

## Laser safety

The CD-ROM and DVD drives used with the HP notebook PC are certified as Class 1 laser devices according to the U.S. Department of Health and Human Services (DHHS) Radiation Performance Standard and International Standards IEC 825 / IEC 825-1 (EN60825 / EN60825-1). These devices are not considered harmful, but the following precautions are recommended:

- Ensure proper use by reading and following the device's instructions carefully.
- If the unit requires service, contact an authorized HP representative—see “To contact HP for support or service” on page 54.
- Do not attempt to make any adjustment of the unit.
- Avoid direct exposure to the laser beam—do not disassemble the drive.

|                                         |
|-----------------------------------------|
| CLASS 1 LASER PRODUCT<br>LASER KLASSE 1 |
|-----------------------------------------|

---

## Regulatory Information

This section presents information that shows how the HP notebook PC complies with regulations in certain regions. Any modifications to the computer not expressly approved by Hewlett-Packard could void the authority to operate the HP notebook PC in these regions.

---

### U.S.A.

This computer has been tested and found to comply with the limits for a Class B digital device, pursuant to Part 15 of the FCC Rules. These limits are designed to provide reasonable protection against harmful interference in a residential installation.

This computer generates, uses, and can radiate radio frequency energy. If not installed and used in accordance with the instructions, it may cause harmful interference to radio communications. However, there is no guarantee that interference will not occur in a particular installation. If this computer does cause harmful interference to radio or television reception (which can be determined by removing the unit's batteries and AC adapter), try the following:

- Reorienting or relocating the receiving antenna.
- Relocating the computer with respect to the receiver.
- Connecting the computer's AC adapter to another power outlet.

#### **Connections to Peripheral Devices**

To maintain compliance with FCC Rules and Regulations, use properly shielded cables with this device.

For more information, consult your dealer, an experienced radio/television technician, or the following booklet, prepared by the Federal Communications Commission: *How to Identify and Resolve Radio-TV Interference Problems*. This booklet is available from the U.S. Government Printing Office, Washington, DC 20402, Stock Number 004-000-00345-4. At the first printing of this manual, the telephone number was (202) 512-1800.

Reference Information  
**Regulatory Information**

**Declaration of Conformity (U.S.A.)**

**Responsible Party:** Hewlett-Packard Company  
Manager of Corporate Product Regulations  
3000 Hanover Street  
Palo Alto, CA 94304, U.S.A.  
+1 (650) 857-1501

declares that the product

**Trade name:** Hewlett-Packard Company

**Product name:** Notebook PC

**Model Number(s):** Pavilion ZE1000 series Notebook PC

complies with Part 15 of the FCC Rules.

Operation is subject to the following two conditions:

1. This device may not cause harmful interference, and
2. This device must accept any interference received, including interference that may cause undesired operation.

# Index

## A

- AC adapter
  - compatibility, 19
  - connecting, 19
  - requirements, 62

## B

- battery
  - charge light, 32
  - charging, 33
  - checking status, 32
  - installing, 18
  - low power warning, 33
  - operating time, 43
  - recharging, 18
  - removing, 18
  - safety, 63
  - saving power. *See Reference Guide*
  - status light, 15
  - troubleshooting, 43

## BIOS

- configuration utility, 47
- boot device order, 26
- brightness
  - adjusting, 28

## C

- Caps Lock status light, 16
- CD/DVD drive
  - status light, 16
- charging batteries, 33
- click buttons
  - configuring, 27
  - using, 26, 27
- copyrights, 2

## D

- default settings, 24
- diagnostics, 45
- display
  - brightness, 28
  - troubleshooting, 40

## E

- e-DiagTools for Windows, 45, 46
- e-mail
  - HP Customer Care, 53

ergonomics, 17, 29

## F

- F10 (diagnostics), 45
- factory software
  - recovering, 49
- files
  - recovering, 49
- floppy disk drive
  - status light, 16
- Fn key
  - + F1 (decrease brightness), 28
  - + F10 (Scroll Lock), 28
  - + F2 (increase brightness), 28
  - + F5 (display select), 28
  - + F8 (keypad), 28
  - + F9 (Num Lock), 28
  - + Home (mute), 28
  - + Page Down (decrease volume), 28
  - + Page Up (increase volume), 28
  - external keyboards, 28

## H

- hard disk drive
  - replacing, 37
  - status light, 16
  - troubleshooting, 41
  - Utility partition, 37
- hardware
  - testing, 45
- Hewlett-Packard support, 40
- hibernation (power mode)
  - entering, 24
  - low battery, 33
  - power status light, 15
  - timeout, 24
- hot keys, 28
- HP Customer Care
  - contact by e-mail, 53
  - telephone numbers, 53
  - web site, 11
- HP Instant Support, 40, 52
- HP Library, 11
- HP Notes, 11

## I

- inventory, 10

## K

- keyboard
  - ergonomic precautions, 17
  - external, 28
  - status lights, 16
  - troubleshooting, 41

## L

- laser safety, 64
- lights
  - status, 16

## M

- maintenance, 24
- memory
  - installing, 36
  - removing, 36
- modem
  - connecting, 20
- mouse
  - troubleshooting, 41

## N

- notebook
  - caring for. *See Reference Guide*
  - default settings, 24
  - protecting, 36
  - registering, 22
  - resetting, 25
  - resuming, 24
  - testing, 45
  - turning on and off, 21, 24
- Num Lock
  - status light, 16

## P

- partition (Utility), 37
- performance troubleshooting, 42
- phone line
  - connecting, 20
  - requirements, 20
- pointing devices
  - configuring, 27
- power
  - connecting AC, 19
  - saving. *See Reference Guide*
  - status light, 15
  - troubleshooting, 43

- power button
  - using, 21
- power cords, 62
- power modes
  - entering, 24
  - hibernation, 24
  - standby, 24
- Q
  - Quick Start* sheet, 11
- R
- RAM
  - installing, 36
  - removing, 36
- recovering
  - hard disk, 49
- Recovery CDs*
  - diagnostics, 46
  - using, 49
- registration, 22
- regulatory information, 65
- reinstalling Windows, 49
- repair service
  - obtaining, 40, 55
  - shipment, 55
- resetting
  - notebook, 25
- S
- safety
  - battery, 63
  - laser, 64
- power cords, 62
- Scroll Lock
  - status light, 16
- scroll toggle
  - using, 27
- service (repair), 40
- software
  - pre-installed, 10
- standby (power mode)
  - power status light, 15
  - resuming from, 24
  - timeout, 24
- startup, troubleshooting, 44
- static electricity
  - precautions, 36
- status lights
  - battery charge, 15, 32
  - Caps Lock, 16
  - CD/DVD drive, 16
  - floppy disk drive, 16
  - hard disk drive, 16
  - keyboard, 16
  - location, 15
  - Num Lock, 16
  - power mode, 15
  - Scroll Lock, 16
- Support Ticket, 46
- system-off switch
  - using, 25
- T
- technical support, 52
- technology codes, 60
- testing hardware, 45
- touch pad
  - configuring, 27
  - troubleshooting, 41
  - using, 26, 27
- troubleshooting
  - battery, 43
  - display, 40
  - hard disk drive, 41
  - HP Instant Support, 40
  - information sources, 40
  - keyboard, 41
  - mouse, 41
  - performance, 42
  - power, 43
  - startup, 44
  - touch pad, 41
- U
- Utility partition
  - creating, 37
- W
- web sites
  - HP Customer Care, 11
  - HP Notebooks, 11
- Windows
  - documentation, 11
  - reinstalling, 49
  - setting up, 21
  - work environment, 29
  - working in comfort, 29