

# User's Manual

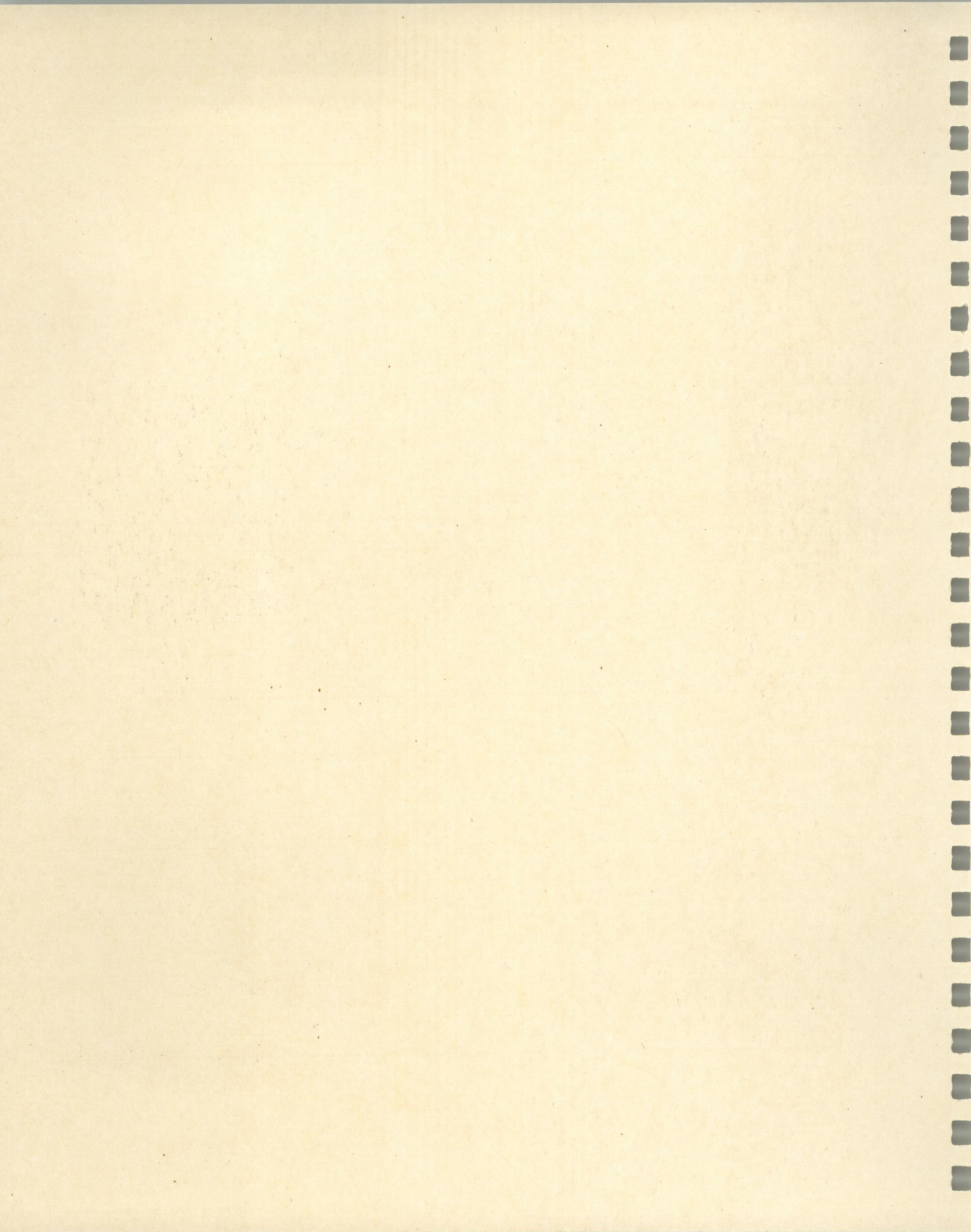

## NOTEBOOK

•Multimedia •Built in 25  $\phi$  Track Ball •Local Bus Display •VESA Local Bus Docking Station





## Notice

*Updating or revising this manual or making any changes to the information herein will be initiated when the company deems it necessary. The company reserves the right to take the above-mentioned actions and is under no obligation to notify any person of such actions in advance or afterwards.*

October 1994

## Trademarks

MS-DOS, Microsoft Windows, and Microsoft Mouse are registered trademarks of Microsoft Corporation.

IBM PC, OS/2, PS/2, EGA, and VGA are registered trademarks of International Business Machines, Inc.

Award BIOS is a trademark of Award Software, Inc.

SimulSCAN is a trademark of Cirrus Logic, Inc.

SystemSoft is a registered trademark of SystemSoft Corp.

Sound Blaster is a trademark of Creative Labs, Inc.

Other brand and product names are trademarks and/or registered trademarks of their respective companies.

## FCC Notice

This equipment has been tested and found to comply with the limits for a Class B digital device, pursuant to Part 15 of the FCC Rules. These limits are designed to provide reasonable protection against harmful interference in a residential installation. This equipment generates, uses, and can radiate radio frequency energy and, if not installed and used in accordance with the instructions, may cause harmful interference to radio communications. However, there is no guarantee that interference will not occur in a particular installation. If this equipment does cause harmful interference to radio or television reception, which can be determined by turning the equipment off and on, the user is encouraged to try to correct the interference by one or more of the following measures:

- Reorient or relocate the receiving antenna.
- Increase the separation between the equipment and receiver.
- Connect the equipment into an outlet on a circuit different from that to which the receiver is connected.
- Consult the dealer or an experienced radio/TV technician for help.

## Warranty Provisions

*The company warrants this personal computer to be in working order for a period of one year from the date of shipment. If this product fails to be in working order during the one year warranty period, the company will, with its option, repair or replace the product at no charge except as set forth below.*

*Warranty service will be furnished on an exchange basis. The company may repair or replace your product with a new or reconditioned one. Any replaced components or parts become the property of the company.*

*No warranty is expressed or implied for products damaged by accident, abuse, misuse, acts of god, or un-authorized modification. No warranties apply after the one year warranty period.*

*To obtain warranty service described herein, deliver the product along with proof of purchase date, to any of the company's authorized distributors during the warranty period. The owner agrees to insure the product and assume the risk of damage or loss in transit, to pay in advance all shipping charges, and to use the original shipping container (or the equivalent).*

*The company is not liable to any purchaser for damage, lost revenue, lost wages, lost savings, or any other incidental or consequential damages arising from the purchase or use of the product or inability to use it.*

## Important safety instructions

Please read and follow these important instructions.

1. Follow all warnings and instructions marked on this product.
2. Unplug this product from the wall outlet before cleaning it or connecting peripheral devices.
3. Use a damp cloth with mild soap to clean this product. Do not apply cleaner directly to the unit. Do not use volatile or abrasive cleaners on this product.
4. Do not place this product on an unstable surface where it may fall.
5. Do not block or cover the system's ventilation openings. Also, never place this product near or over a radiator or heat register, or in a built-in installation unless adequate ventilation is provided.
6. Operate this product in accordance with its rated power specifications. If you are unsure of your local power specifications, consult your dealer or local power company.
7. This product is equipped with a 3-wire grounding type plug. This is an important safety feature; do not defeat its purpose. If you do not have access to such power, have a qualified electrician install a proper outlet.
8. Do not allow anything to rest on the power cord. Do not locate this product where persons will likely walk on the cord.

9. If an extension cord is used with this product, make sure the total current drawn by the products plugged into the extension cord do not exceed the extension cord or outlet power ratings.
10. Do not allow foreign matter to enter the system.
11. Do not attempt to service this product yourself. Opening or removing covers may expose dangerous voltage points. Refer all repair work to qualified service personnel.
12. Unplug this product from the wall outlet, do not operate it, and immediately seek proper servicing if:
  - a. The power cord or plug is damaged or frayed.
  - b. Liquid or foreign matter has entered this product.
  - c. This product has been exposed to rain or water.
  - d. This product has been dropped or damaged.
  - e. This product exhibits a distinct change in performance, indicating a need for service.
13. Do not use any battery pack other than the one specifically designed for this system. Batteries may explode or leak if exposed to fire or improperly handled or guarded. Refer battery replacement to your dealer or qualified service personnel.

14. Only use UL listed/CSA certified, type SVT/SJT power cords rated 6A 250V minimum (VDE approved or equivalent). It should be a detachable type with a minimum length of 6 feet.
15. Adjust only those controls that are covered by these operating instructions. Improper adjustment of other controls may result in serious damage to the system which is not covered by the warranty.

Only use UT-1000 or UT-1000A power cards (part of 250V minimum VDE approved equipment). If you use a different type with a minimum length of 100mm.

Adjust only those controls provided by these operating instructions. Adjustment of other controls may result in damage to the system which is not covered by the warranty.

# *Table of Contents*

## **Chapter 1: Getting Started**

Overview .....	2
Getting Started.....	2
Unpacking.....	2
A Brief Introduction .....	4
Operating Environment .....	5
Basic Operation .....	7
Power .....	7
AC Power.....	7
Battery Power.....	9
Recharging Battery Packs by AC Power ...	9
Recharging Battery Packs by Charger .....	9
Remark .....	10
Setup and Operation .....	13
Open the Top Cover/Display Panel .....	13
Turn the System Power On.....	13

## Chapter 2: The System

Overview .....	2
Description .....	3
Indicators .....	3
Top-Front View .....	6
Display Panel .....	6
Power Switch .....	6
Speaker.....	6
Microphone .....	6
Trackball Pointing Device .....	6
Right View .....	8
Fan/Ventilation Port.....	8
3.5", 1.44 MB Floppy Diskette Drive.....	8
Right-Side Top Cover Latch.....	8
Speaker-Out Jack .....	8
Line-In Jack .....	8
Microphone-In Jack .....	8
Rear View .....	10
DC-In Socket .....	10
Expansion Port.....	10
External Monitor Port .....	10
Parallel Port.....	10
Serial Port.....	10
External Keyboard Port .....	11
Left View .....	13
PCMCIA Type IV Expansion Slot .....	13

Removable 2.5" Hard Disk Drive .....	13
Left-Side Top Cover Latch .....	13
Operation .....	15
The System .....	15
Restarting the System .....	15
Warm Boot .....	15
Cold Boot .....	15
Changing Operating Speed .....	16
The Keyboard .....	17
Alphanumeric Key Group .....	18
Edit Key Group .....	20
Cursor Control Keys .....	21
Up Arrow Key .....	21
Down Arrow Key .....	21
Right Arrow Key .....	21
Left Arrow Key .....	21
AT "F" Keys .....	21
System Function Key .....	21
Embedded Numeric Keypad .....	22
Disk Drives .....	24
3.5" Floppy Drive and Diskettes .....	24
Inserting/Removing Diskettes .....	24
Write-Protecting Diskettes .....	26
Do's and Don'ts .....	26
Hard Disk Drive .....	27
PCMCIA Slot .....	29

Inserting and Removing Cards ..... 29  
Configuring and Operating Cards..... 29  
Audio System ..... 31  
Trackball Pointing Device ..... 31  
External Monitor..... 32

## Chapter 3: Utilities

Overview .....	2
Power-On Self Test (POST).....	2
Screen Messages.....	3
POST: Normal Operation .....	3
POST: Error Detected .....	4
Beep Messages.....	5
The CMOS Setup Utility .....	6
Information in the Setup Menu.....	6
Invoking the Setup Menu .....	7
Making Changes in the Main Menu .....	9
Making Changes in the Sub-menu .....	10
Standard CMOS Setup.....	10
BIOS Features Setup.....	11
Load BIOS Defaults.....	12
Load Setup Defaults.....	12
Password Setting.....	13
IDE HDD Auto Detection.....	13
Save & Exit Setup.....	14
Exit Without Saving.....	14
Features of the CMOS Setup Utility.....	15
Standard CMOS Setup.....	15
BIOS Features Setup.....	18
Load BIOS Defaults.....	21
Load Setup Defaults.....	22
Password Setting .....	23

IDE HDD Auto Detection.....	24
Save & Exit Setup.....	25
Exit Without Saving.....	26
The BIOS Utility .....	27
Operating Modes .....	27
Pop-up Menu Mode .....	27
Immediate Mode .....	28
Features of the BIOS Utility .....	29
Feature Descriptions .....	31
Power Management Unit (PMU).....	31
Display Features.....	31
Text Reverse Display Mode.....	31
Graphics Reverse Display Mode.....	31
Expanded Display Mode .....	31
Centering Display Mode .....	32
Display Type .....	32
Trackball .....	33
Special Procedures for Windows .....	33
Sleep/Power Conservation Features .....	34
HDD .....	34
Panel .....	34
Under DOS Prompt .....	34
Under Windows 3.1.....	35
Display Control Features .....	36
Contrast Control .....	36
Brightness Control .....	36

Audio System Control Features .....	36
Volume Control.....	36
PCMCIA Drivers.....	37
Description.....	37
Socket Services .....	37
Card Services .....	37
Other Drivers .....	37
Installation and Usage .....	38

## Appendices

Overview .....	1
Appendix A: Specifications.....	2
Appendix B: I/O Port Pin Assignments .....	4
Appendix C: Keyboard Scan and ASCII Codes .....	6
Appendix D: Sound Switch Configuration .....	8



# CHAPTER 1

## Getting Started



## Overview

This chapter provides a short introduction and tutorial that will familiarize you with the Notebook Computer system and get you up and running quickly. It provides:

- A first look at the system.
- Basic information you need to know before you operate the system for the first time.
- An introduction to setting up and turning on the system.

For detailed explanation of the Notebook Computer's features and operation, refer to the following chapters.

## Getting Started

### Unpacking

Before doing anything else, carefully unpack the Notebook Computer and its included accessories.

- Notebook Computer.
- Carrying Bag.
- Universal Power Adapter.
- AC Power Cord.
- User's Manual.
- PS/2 Keyboard Transfer Cable.
- Utilities Diskette.

If there are any discrepancies or problems, contact your dealer immediately. Be sure to save the packing materials in case you need to repack and ship the Notebook Computer in the future.

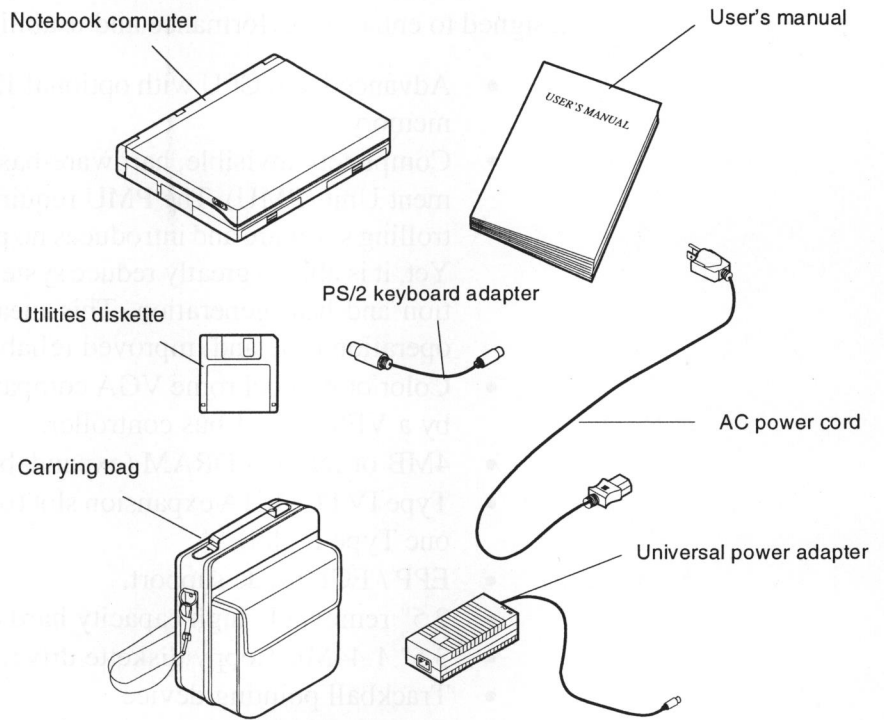

**Figure 1-1**  
*The Notebook Computer and its included accessories*



## **A Brief Introduction**

The Notebook Computer is a state-of-the-art, high-performance, notebook computer system. It offers a host of features specially designed to enhance performance and usability:

- Advanced 486 CPU with optional 128K external cache memory.
- Completely invisible, hardware-based Power Management Unit (PMU). The PMU requires no external controlling software and introduces no performance losses. Yet, it is able to greatly reduce system power consumption and heat generation. This means longer portable operation time and improved reliability.
- Color or monochrome VGA compatible display driven by a VESA local-bus controller.
- 4MB of internal DRAM (expandable to 36MB).
- Type IV PCMCIA expansion slot (one Type III slot and one Type II slot).
- EPP / ECP mode support.
- 2.5" removable high capacity hard disk drive.
- 3.5" 1.44MB floppy diskette drive.
- Trackball pointing device.
- Rechargeable, high energy internal battery packs.
- Extended multi-function keyboard.
- Microsoft sound system, Sound Blaster compatible.
- Eight external ports to connect:
  - An external keyboard.
  - An external super-VGA monitor.
  - A parallel device.
  - A serial device.
  - A docking station.
  - A microphone-in device.
  - A line-in device.
  - A speaker-out device.



## Operating Environment

Thanks to the Notebook Computer's ability to run on battery power, its compactness in size, and light weight, it can be conveniently operated wherever the temperature and humidity are comfortable enough for you to work.

If you properly care for the Notebook Computer, it will provide many years of reliable service. However, remember this computer system is a precision instrument and it should not be:

- Exposed to excessive heat or direct sunlight.
- Subjected to shock or vibration.
- Exposed to strong magnetic fields.
- Left in a place where foreign matter or moisture may enter the system.

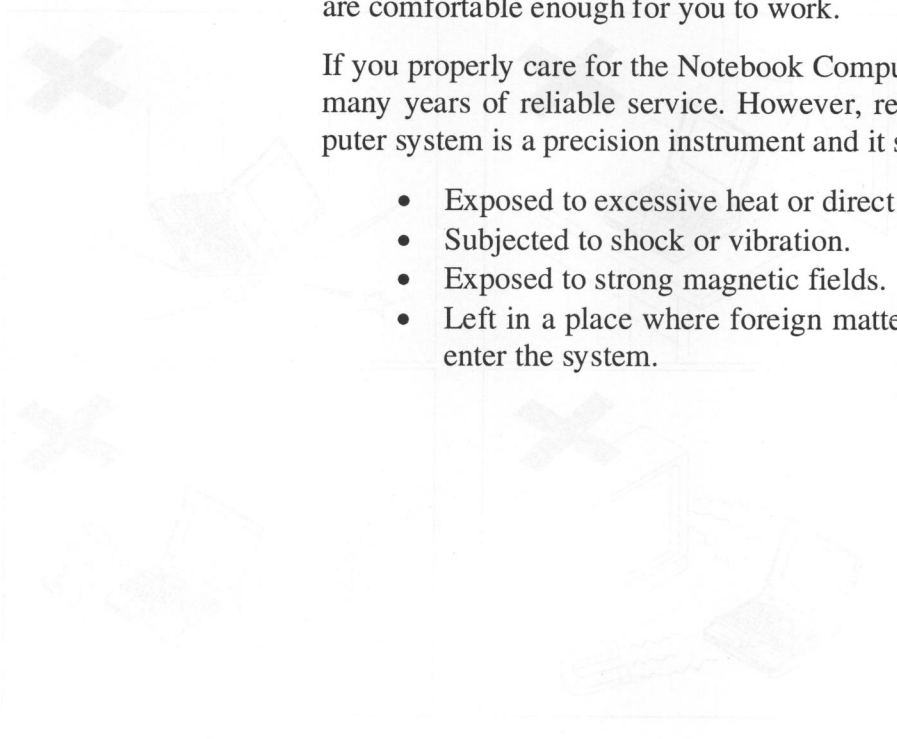
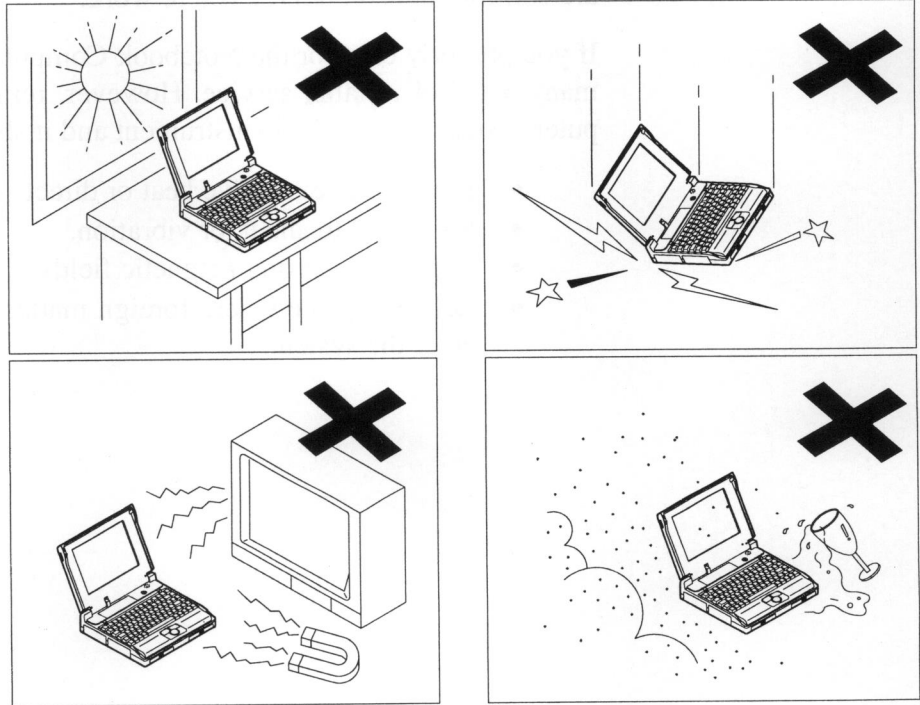

Figure 1-2  
Caring for the Notebook Computer



**Figure 1-2**  
*Caring for the Notebook Computer*

# Basic Operation

## Power

Before using the Notebook Computer, you must supply it power. If this is the first time the Notebook Computer is operated, you should use the AC power source since the internal battery packs may have self-discharged during shipment.

### Note

Use no other AC adapter but the one included in the accessories together with the Notebook Computer to avoid the system damage incurred.

### AC Power

The Notebook Computer features a universal, auto-switching power adapter. This adapter is suitable for use nearly anywhere.

1. Make sure the local AC mains (input voltage) falls within the operating range of the power adapter. If not, you may need to use an additional power converter.
2. Connect the AC power cord to the power adapter.
3. Plug the power adapter to the DC-In socket on the rear panel of the Notebook Computer.
4. Plug the AC power cord into a properly grounded outlet.
  - The concerned light (described in *Chapter 2, the System*) on the Notebook Computer will light up red to indicate the unit is receiving power, other than green when the battery power is used.

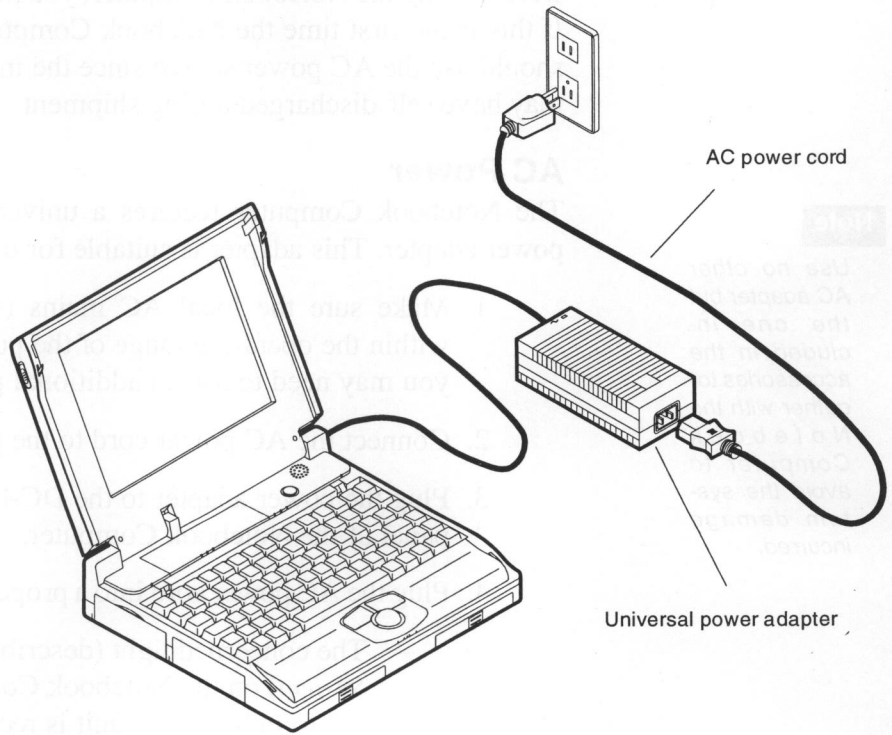

**Figure 1-3**  
*Using the Notebook Computer with its universal power adapter*



## Battery Power

The Notebook Computer is equipped with two internal, rechargeable battery packs on either side of the front panel which can provide up to three hours of continuous, portable operation.

### *Recharging the Battery Packs by AC Power*

The system's battery packs will recharge when the system is plugged into the AC power supply with *power off*. Please note the following points:

- You may connect the AC power adapter to the Notebook Computer when the system power is turned off to begin recharging the system's battery packs.
- After the battery packs are fully recharged, the concerned indicators (described in *Chapter 2, the System*) which show the power status of the battery packs will light up green.
- Recharge time is approximately one hour per NiCD battery pack, or one and an half hours per NiMH battery pack.

### *Recharging the Battery Packs by Battery Charger*

The system's battery packs can be recharged by the optional battery charger through the AC power supply as well.

- Press down the corrugated surface located on both sides of the front panel of the Notebook Computer to unload the battery packs.
- Load the battery packs in the right position of the battery charger.
- Connect the AC power adapter to the battery charger to recharge the battery packs.



### *Remark*

The internal NiMH battery packs of the Notebook Computer need to be activated *the very first time* the system is operated.

- The recharge time might be double or triple what it is usually after the battery full / low LEDs light up green.
- The battery power actually has not yet fully recharged though it seems. Unload the battery packs to have them cool off for the next recharge.
- Reload the battery packs to recharge the power again.
- Repeat the procedures above at least three times.

You may follow the procedures mentioned above encountering battery over-discharge problem especially when the system is not turned off running out of the battery power without AC power supply.

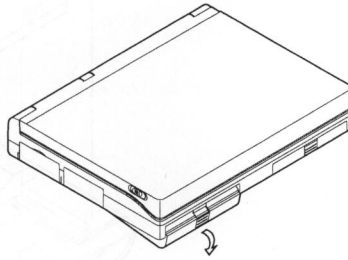

**Figure 1-4**  
*Press down the corrugated surface to unload the battery packs*

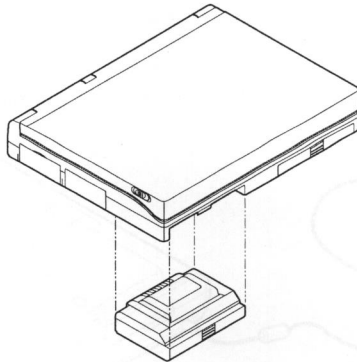

**Figure 1-5**  
*Unload the battery packs*

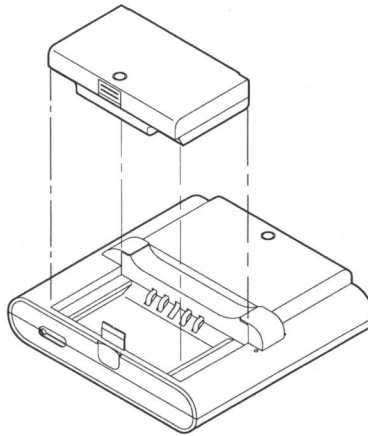

**Figure 1-6**  
*Load the battery packs into the battery charger*

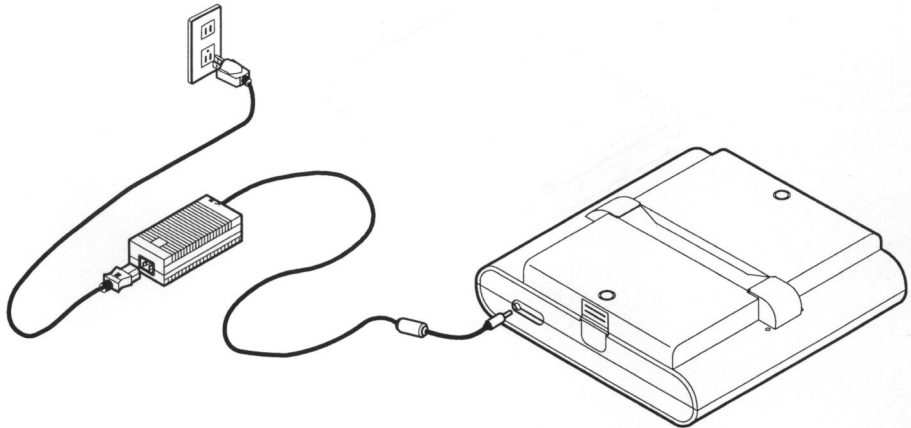

**Figure 1-7**  
*Using the battery charger with the AC power adapter*



## Setup and Operation

### Open the Top Cover/Display Panel

The Notebook Computer's display panel is integrated into the system's top cover which locks shut for transportation. Open the top cover as follows:

1. Unlatch the two clasps located along the sides of the top cover of the Notebook Computer by sliding them forward.
2. Lift the top cover to reveal the display panel, keyboard and system controls.
3. Raise the display panel to a comfortable viewing angle.

### Turn the System Power On

The system power button is located on the top cover.

1. Press the power button once to turn the system on. Press it again to turn the system off.
  - The system will start, perform a self-test, and attempt to boot.
2. After the system is in operation, adjust the display controls and display panel angle for optimum screen clarity.

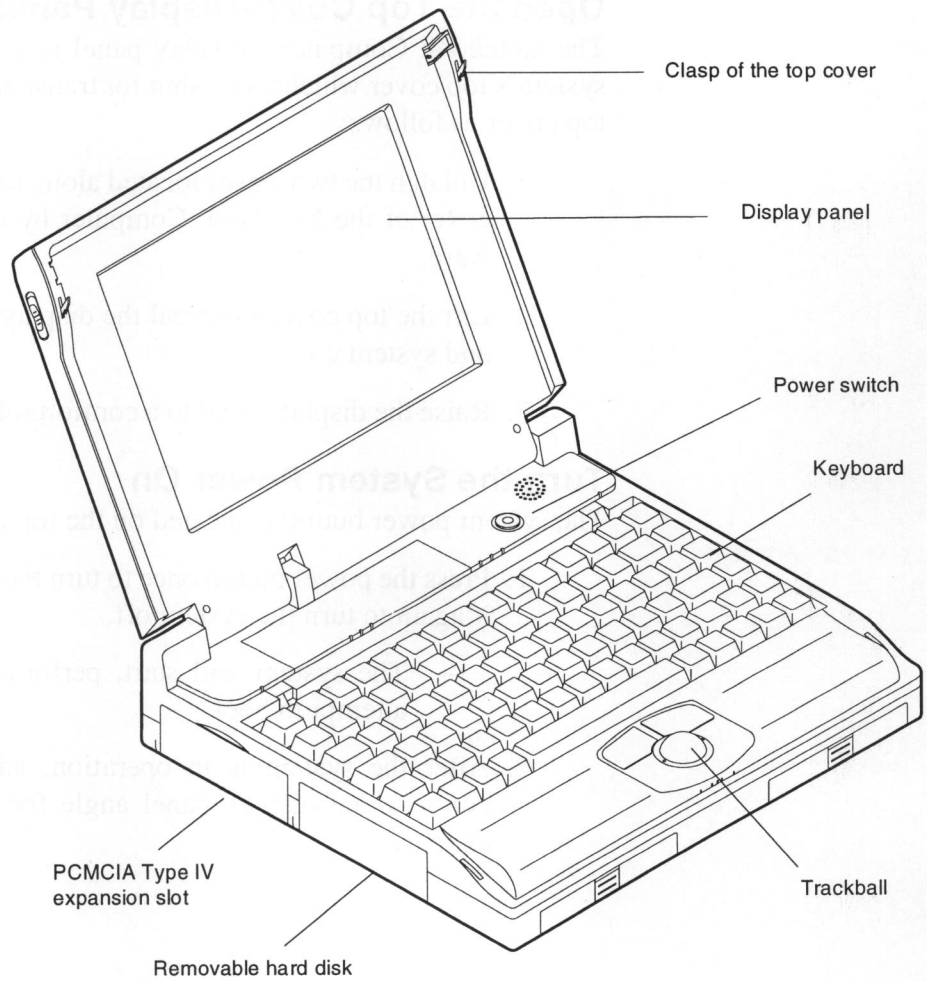

**Figure 1-8**  
*Layout of the Notebook Computer*



The Notebook Computer contains many advanced features to help you with your computing. This chapter describes each of the Notebook Computer features in detail and shows you how to use them.

# *CHAPTER 2*

# *The System*



# Overview

The Notebook Computer has many advanced features to help you with your computing work. This chapter describes each of the Notebook Computer's hardware features in detail and shows you how to use them. It covers:

- A description of the system unit and its features.
- How to use:
  - The system.
  - The keyboard.
  - The trackball.
  - The disk drives.
  - The PCMCIA expansion slot.
  - The audio system.
  - An externally connected monitor.

# Description

## Indicators

The Notebook Computer features ten LED indicator lights to alert you of the system's status, and one icon indicator to the function.



This indicator lights up red when the AC power adapter is used and green when battery power is used.



This icon indicates the power switch.



This indicator lights up while the floppy diskette drive is being accessed.



This indicator lights up while the hard diskette drive is being accessed.



This indicator lights up when the system is running in the "turbo" mode, (the maximum rated speed of the CPU).



This indicator lights up when the scroll lock function is activated.



This indicator lights up when the caps lock function is activated.



## Chapter 2: The System

---



This indicator lights up when the system's embedded numeric keypad function is activated.



This indicator lights up when the system's *Fn* key is locked on.



There are two indicators respectively showing the power status of the left and right battery packs. Either indicator lights up red when the power of the concerned battery pack is low. Both indicators light up red and *flash with beep sound* when both battery power is low. And it lights up green when the battery pack is fully recharged.

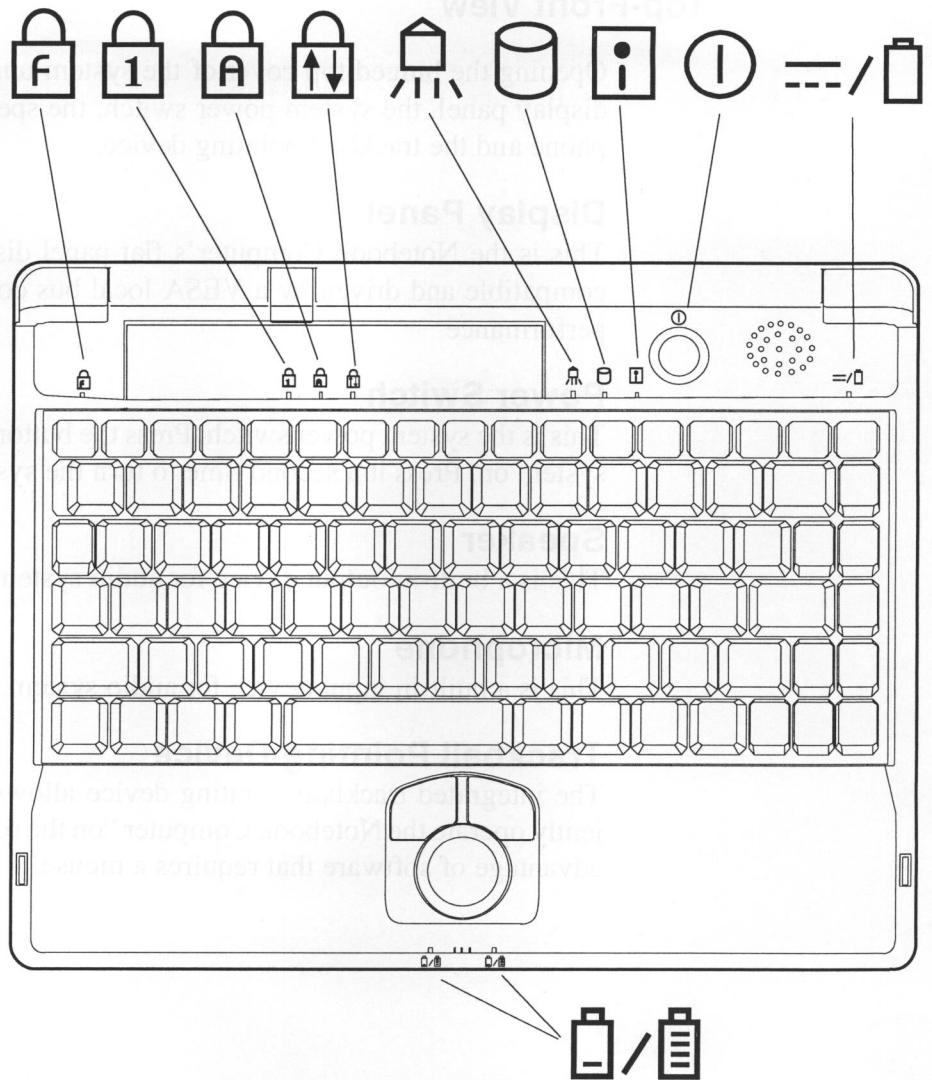

**Figure 2-1**  
*Indicators of the Notebook Computer*



## **Top-Front View**

Opening the hinged top cover of the system unit will reveal the display panel, the system power switch, the speaker, the microphone and the trackball pointing device.

### **Display Panel**

This is the Notebook Computer's flat panel display. It is VGA compatible and driven by a VESA local bus controller for high performance.

### **Power Switch**

This is the system power switch. Press the button once to turn the system on. Press it a second time to turn the system off.

### **Speaker**

This is a built-in output device for audio system.

### **Microphone**

This is a built-in input device for audio system.

### **Trackball Pointing Device**

The integrated trackball pointing device allows you to conveniently operate the Notebook Computer "on the road" and still take advantage of software that requires a mouse.

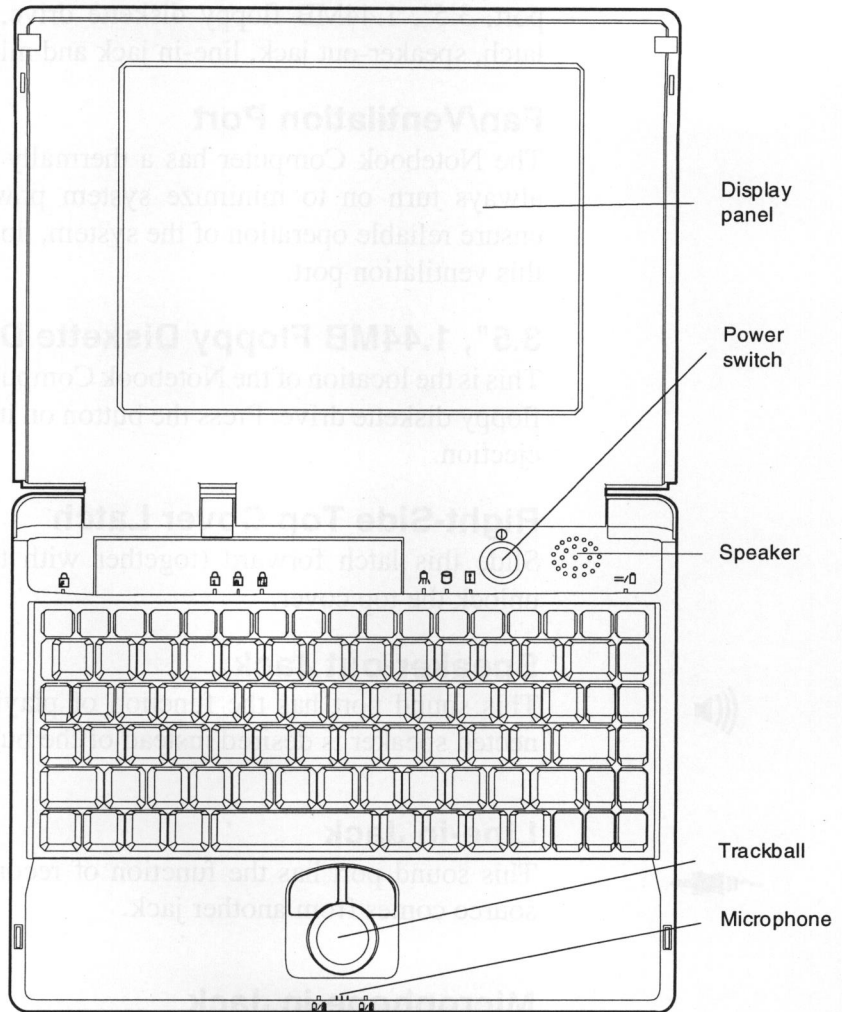

**Figure 2-2**  
*Top-front view of the Notebook Computer*



## Right View

On the right side panel, you will find the system's fan/ventilation port, 3.5", 1.44MB floppy diskette drive, right-side top cover latch, speaker-out jack, line-in jack and microphone-in jack.

### Fan/Ventilation Port

The Notebook Computer has a thermally activated fan. It will always turn on to minimize system power consumption. To ensure reliable operation of the system, do not obstruct or cover this ventilation port.

### 3.5", 1.44MB Floppy Diskette Drive

This is the location of the Notebook Computer's 3.5" high density floppy diskette drive. Press the button on its left side for diskette ejection.

### Right-Side Top Cover Latch

Slide this latch forward (together with the left-side latch) to unlock the top cover.

### Speaker-out Jack

This sound port has the function of playing if externally connected speaker is desired instead of the built-in one.

### Line-in Jack

This sound port has the function of recording when the sound source comes from another jack.

### Microphone-in Jack

This sound port has the function of recording when externally connected microphone is used.



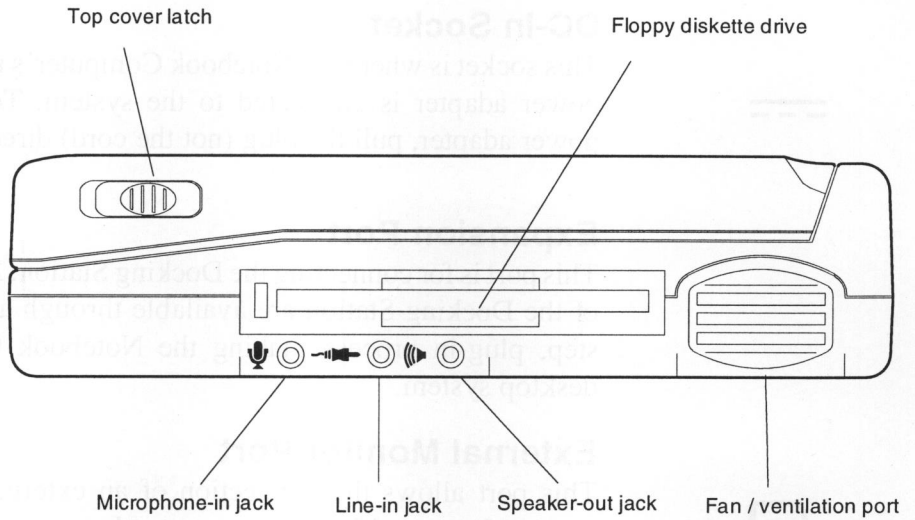

**Figure 2-3**  
*Right-side view of the Notebook Computer*



## Rear View

The rear panel of the Notebook Computer features six ports for the connection of an external power supply, a docking station, an external Super-VGA monitor, a parallel device, a serial device and an external keyboard.

### DC-In Socket

This socket is where the Notebook Computer's universal AC/DC power adapter is connected to the system. To disconnect the power adapter, pull the plug (not the cord) directly back.



### Expansion Port

This port is for connecting the Docking Station. All of the features of the Docking Station are available through a convenient one-step, plug-in process making the Notebook Computer a true desktop system.

### External Monitor Port

This port allows the connection of an external monitor to the system. It uses a 15-pin connector and supports super-VGA, and SimulSCAN features.



### Parallel Port

This is a parallel port to connect a printer for example. It supports EPP (Enhanced Parallel Port) and ECP (Extended Capabilities Port) modes, but required as well is the use of the connected parallel device's software driver.



### Serial Port

This is an RS-232 serial port to connect an external mouse for example. It features a 9-pin connector.





### External Keyboard Port

An external PS/2 compatible keyboard can be connected to the system through this port. A PS/2 keyboard transfer cable has been included to allow the use of standard AT keyboards with this system.



Figure 2-4  
Rear view of the Notebook

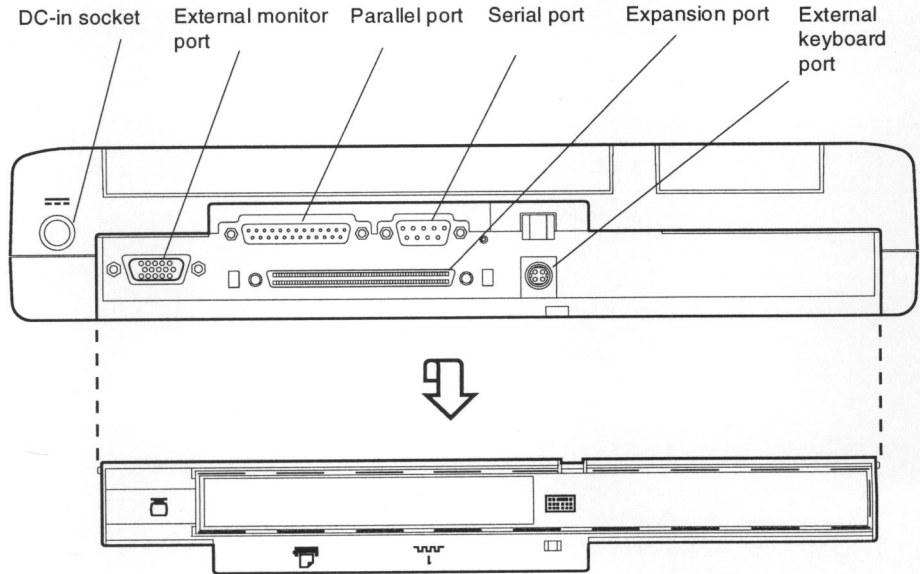

**Figure 2-4**  
*Rear view of the Notebook Computer*



## Left View

The left side of the Notebook Computer features a PCMCIA expansion slot, a removable 2.5" hard disk drive and a left-side top cover latch.

### PCMCIA Type IV Expansion Slot

The Type IV PCMCIA expansion slot is located inside a flip-down panel. It allows you to conveniently attach numerous accessories to the Notebook Computer. It is equivalent to one Type III PCMCIA slot and one Type II PCMCIA slot. The ejection button for the upper slot is located on the left. The ejection button for the lower slot is on the right.



### Removable 2.5" Hard Diskette Drive

The 2.5" hard disk drive is removable for easy carrying and easy replacing as well as data security.

### Left-Side Top Cover Latch

Slide this latch forward (together with the right-side latch) to unlock the top cover.

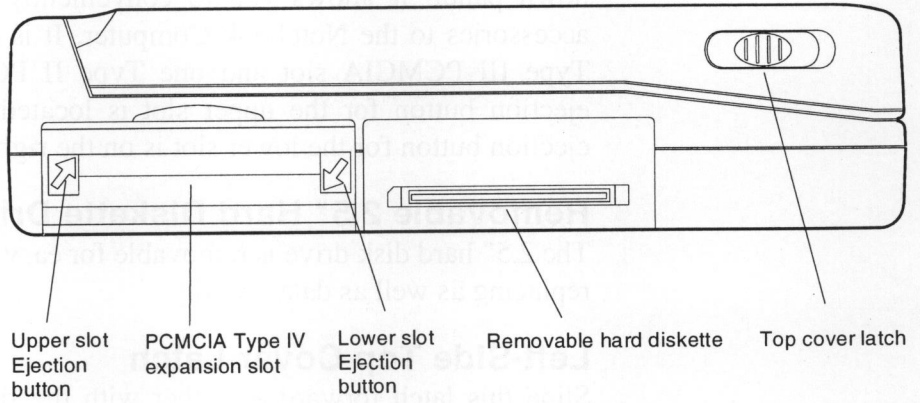

**Figure 2-5**  
*Left-side view of the Notebook Computer*

# Operation

## The System

### Restarting the System

If you experience operating problems with the Notebook Computer, you may restart the computer using either of the following techniques:

#### Note

If you experience problems restarting the Notebook Computer using the “warm” boot method, use the “cold” boot method.

#### Warm Boot

Restarts the system with a power and time saving, shortened version of the POST (see the next section for a description of POST). This method will usually reset the system but *may* not completely clear the contents of RAM memory.

1. Simultaneously press the *Ctrl*, *Alt*, and *Del* keys.
  - The screen should go blank and then the system should restart. If it does not, you must cold boot the system.

#### Cold Boot

Restarts the system by completely resetting the Notebook Computer’s CPU and RAM memory and forces the system to perform a complete POST. This method thoroughly eradicates all data in the system’s RAM memory.

1. Turn the system power off.
2. Wait a few seconds.
3. Turn the power back on.



## Changing Operating Speed

The Notebook Computer is capable of operating at two different speeds. Most of the time you will want to use the “turbo” mode for maximum processing speed. However, some older software is timing dependent and will not work well at the higher speeds offered by the 486 CPU. Therefore, you may switch to “standard” mode and force the CPU to run at low speed. To change the system operating speed:

### Note

“Turbo” mode is the fastest rated speed of the CPU.

1. Make sure the system is operating in a DOS-based mode or exit your application software and return to the DOS prompt.

#### 2a. Turbo Mode

To place the CPU in “turbo” mode, simultaneously press either the **Ctrl, Alt, ↑** three keys or the **Ctrl, Alt, +** (keypad) three keys.

- The system will beep twice and the Turbo indicator will light up.

#### 2b. Standard Mode

To place the CPU in “standard” mode, simultaneously press either the **Ctrl, Alt, ↓** three keys or the **Ctrl, Alt, -** (keypad) three keys.

- The system will beep once and the Turbo indicator will turn off.

The operating speed is automatically set when the system is started. The default speed may be changed from within the CMOS Setup Utility.

## The Keyboard

The Notebook Computer utilizes an 86 key keyboard. It is laid out slightly differently from a standard AT keyboard, but it offers all of the same functions plus some special specific features of the Notebook Computer. The keyboard can be divided into the following functional groups:

- Alphanumeric key group.
- Edit key group.
- Cursor control keys.
- AT "F" keys.
- Notebook Computer special function key.
- Embedded numeric keypad.

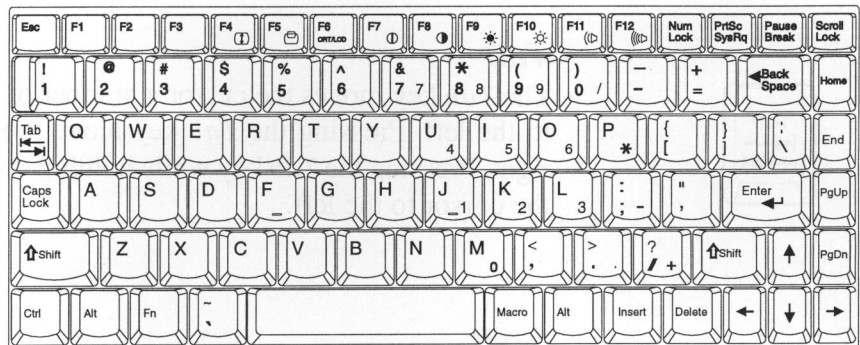

**Figure 2-6**  
Layout of the Notebook Computer's keyboard



**Note**

*These keyboard function descriptions are for the DOS command line. Their functions may vary with different software.*

## Alphanumeric Key Group

The main part of the keyboard is the alphanumeric key group which is used for entering most of your data. The keys in this group are arranged similarly to those of a standard typewriter and they are used in the same way. These keys are typematic, (self repeating) and will automatically repeat the same character if held down.

Some of the keys in this group have special functions or are not found on standard typewriters. Functional descriptions of these special keys are given below.

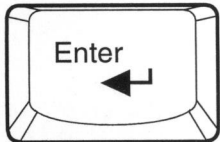

### *Enter*

The *Enter* key is equivalent to the Return key on an electric typewriter. Pressing this key enters data on the screen into the computer and moves the cursor to the beginning of the next line.

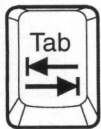

### *Tab*

The *Tab* key moves the cursor a number of spaces to the right or to the left. Pressing the *Tab* key alone moves the cursor to the right. Pressing the *Tab* key while holding down a *Shift* key moves the cursor to the left.

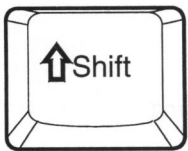

### *Shift*

There are two *Shift* keys on the keyboard; one is on the left side and the other is on the right side. Holding down a *Shift* key while typing will place shifted characters on the screen, this includes uppercase letters, and symbols located over the number and punctuation keys.



### *Caps Lock*

Pressing the *CapsLock* key once, turns on its status light and shifts all letter keys from lower-case to uppercase. It does not affect number or symbol keys. Pressing this key again releases the *CapsLock* function and turns its status light off.

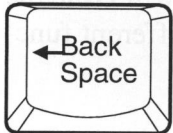

### *Backspace*

The *Backspace* key deletes characters on the screen while moving the cursor toward the left.

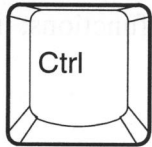

### *Control*

The *Control* key is used in combination with other key(s) to perform specific functions or commands depending on the software being used.



### *Alt*

The *Alt* key is used in combination with other key(s) to perform specific functions or commands depending on the software being used.



### *Scroll Lock*

The *Scroll Lock* key is used to perform special operations. Its particular function depends on the software being used.

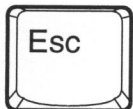

### *Escape*

The *Esc* key is used to perform special operations. Its particular function depends on the software being used.



### ***Print Screen***

Pressing the *PrtSc* key while the system is operating in a text mode will send an ASCII screen dump to the printer.

### ***System Request***

Pressing this key while holding down the *Ctrl* key will issue the SysRq command to the system. SysRq performs different functions depending on the software being used.

### ***Pause***

Pressing the *Pause* key will issue the Pause command to the system. Pause temporarily freezes the system's functions; it restores them after any other key is pressed.



### ***Break***

Pressing this key while holding down the *Ctrl* key will issue the Break command to the system. Break stops the system's current function and returns you to the DOS prompt.

### ***Edit Key Group***

The keys labeled *Ins*, *Del*, *Home*, *End*, *PgUp*, and *PgDn* are known as "edit keys." They are often used to format text that is typed into the computer. Their functions are software-specific. Refer to your DOS and software manuals for details regarding their usage.

### Cursor Control Keys

Four cursor control keys, also called *Arrow* or *Direction* keys, are located below the *Enter* key. The function of these keys depends upon the software being used.

#### Up Arrow Key

This key moves the cursor one line up.

#### Down Arrow Key

This key moves the cursor one line down.

#### Right Arrow Key

This key moves the cursor one space right.

#### Left Arrow Key

This key moves the cursor one space left.

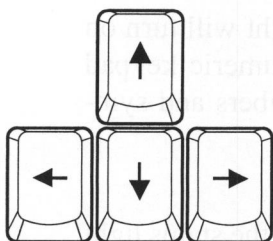

### AT “F”Keys

Located along the top of the keyboard are 12 numbered “F” keys. They are part of the standard IBM-compatible extended keyboard layout. The functions of these “F” keys vary from one software program to another. Refer to your software manual for details on how they are used.

### System Function Key

Located on the bottom-left edge of the Notebook Computer keyboard is an Fn key. It is a special key only found on the Notebook Computer and it is used to:

- Change Notebook Computer BIOS Utility settings.

The *Fn* key is discussed in detail in the next chapter.





**Note**

You must turn off the numeric keypad function to type in the normal alphanumeric mode.

## Embedded Numeric Keypad

Sixteen keys in the middle of the keyboard are capable of providing numeric keypad functions.

To activate these functions:

1. Press the NumLock key to activate the embedded numeric keypad mode.
  - The system's NumLock status light will turn on and the keys of the embedded numeric keypad will use the smaller, colored numbers and symbols on the keys.
2. Press the NumLock key again to turn off the status light and return to the standard alphanumeric keyboard mode.

The embedded numeric keypad functions will become inactive once an external keyboard is connected, so will the system's NumLock LED indicator. The sixteen keys therefore will be *always* in the standard alphanumeric keyboard mode, instead of the numeric keypad one exclusively controlled by the external keyboard.

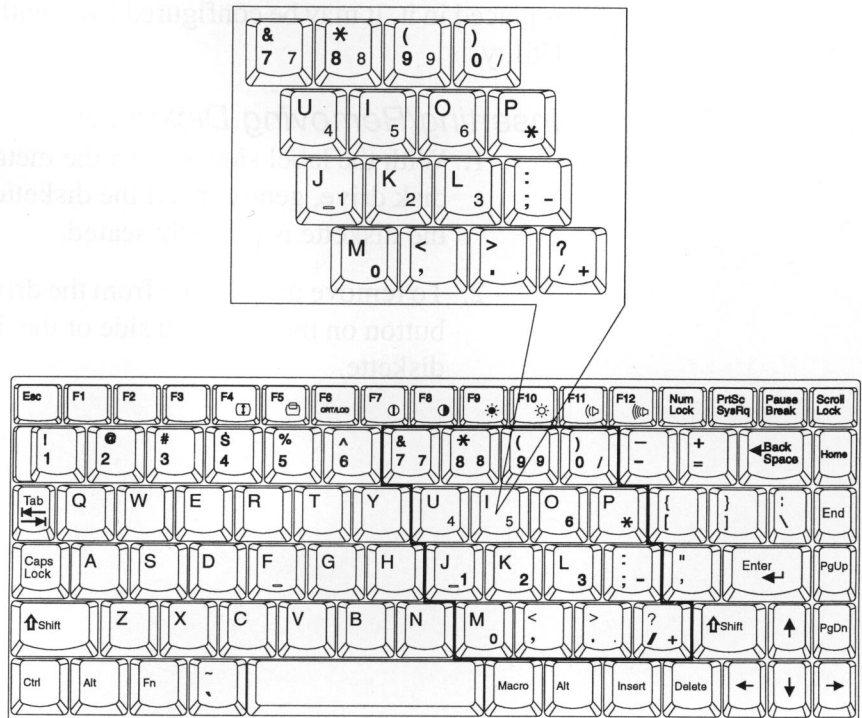

**Figure 2-7**  
Keys of the embedded numeric keypad



## **Disk Drives**

The Notebook Computer is equipped with one 2.5", high capacity hard diskette drive, and one 3.5", 1.44MB floppy diskette drive.

### **3.5" Floppy Drive and Diskettes**

The Notebook Computer's floppy diskette drive is labeled drive A: It is capable of starting the system when a bootable diskette is placed in it. It may be configured from within the CMOS Setup Utility.

#### *Inserting/Removing Diskettes*

1. With the label side up, and the metal shutter toward the disk drive, gently insert the diskette into the drive until the diskette is properly seated.
2. To remove the diskette from the drive, press the ejection button on the left-hand side of the drive and remove the diskette.

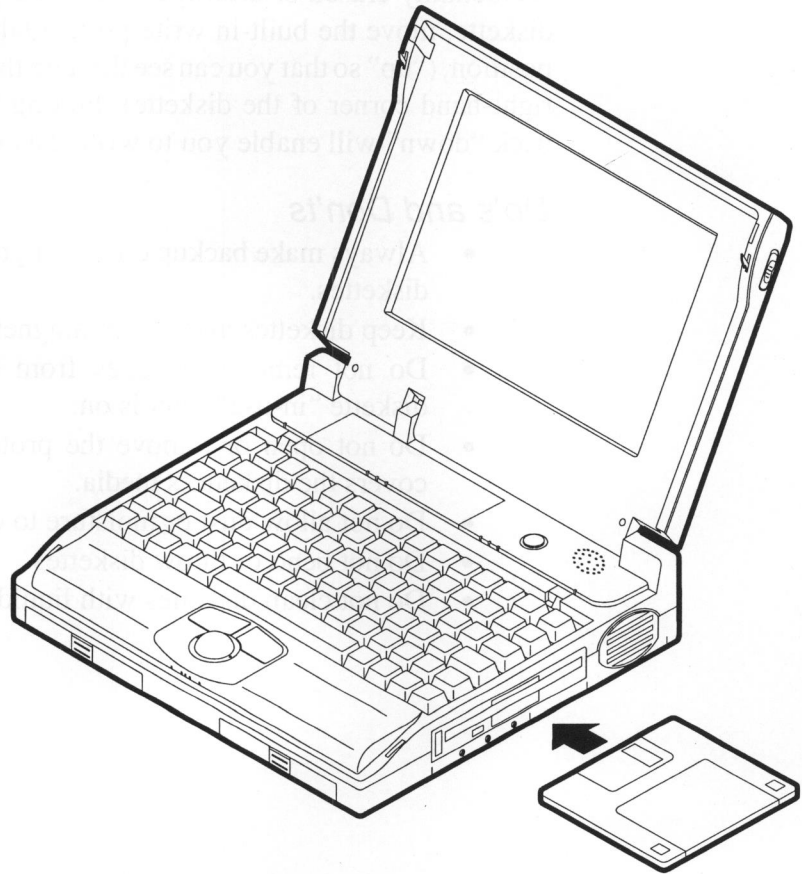

**Figure 2-8**  
*The Notebook Computer's floppy diskette drive*



### *Write-Protecting Diskettes*

Diskettes can be write-protected to prevent files from being accidentally erased or destroyed. To write-protect a 3.5" floppy diskette, move the built-in write-protect tab to the write-protect position, ("up" so that you can see through the "hole" in the upper, right-hand corner of the diskette). Putting the write protect tab back "down" will enable you to write data on the disk again.

### *Do's and Don'ts*

- Always make backup copies of your software and data diskettes.
- Keep diskettes away from magnetic fields.
- Do not remove diskettes from the drive while the diskette "in-use" light is on.
- Do not open or remove the protective shutter which covers the diskette's media.
- Do not allow dust or moisture to collect on diskettes.
- Do not bend or throw diskettes.
- Do not clean diskettes with liquids or solvents.

## Hard Disk Drive

The Notebook Computer's 2.5" hard disk drive will automatically start when the system power is turned on. The 2.5" hard disk drive is removable for easy carrying and easy replacing as well as data security. ***Be sure that the system power is turned off if you want to remove the hard disk from the system.***

The hard disk drive comes from the factory pre-formatted and configured for use with MS-DOS. However, it contains no files and is not capable of booting (starting) the system.

If the hard disk drive is not bootable, you must start the system with a bootable diskette in floppy diskette drive A:

The hard disk drive comes formatted from the factory but contains *no* files. If you wish to have your system automatically boot from the hard disk drive, reformat it using the /s switch.

Refer to your DOS manual for more details about hard disk drives, DOS files, starting your system and formatting disks.

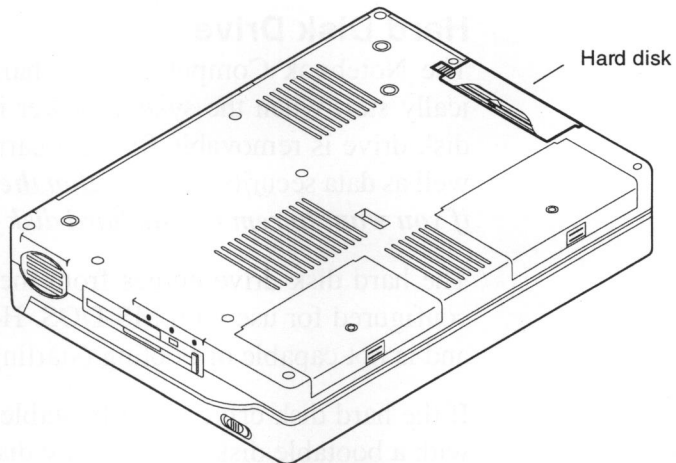

**Figure 2-9**  
*Location of the hard disk*

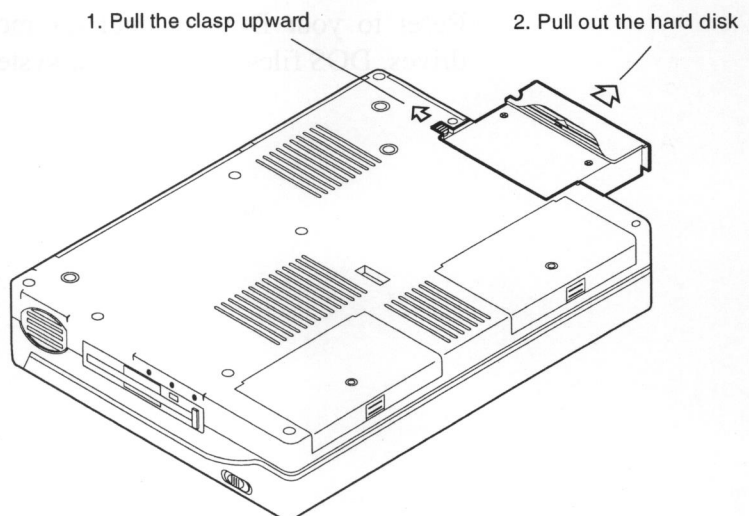

**Figure 2-10**  
*Remove the hard disk out of the system*

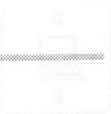

## PCMCIA Slot

The Notebook Computer includes a Type IV PCMCIA expansion slot. It may be used to install:

- Network or SCSI adapters.
- FAX/modem devices.
- Memory devices.
- PCMCIA compatible hard disk drives.
- Communication devices.

### Note

*If you use OS/2 as the computer's operating system, you must **turn off** the computer before inserting or removing a PCMCIA card.*

## Inserting and Removing PCMCIA Cards

PCMCIA cards are inserted and removed in much the same way as floppy disks. Although PCMCIA cards are electronic devices, you do not need to turn off the system power to change them. Exit any applications you are using and return to the DOS prompt before inserting or removing a PCMCIA card.

- To insert a card into the slot, align the card with the slot and push it in firmly until it locks into place.
- To remove a card from the upper slot, press the card eject button on the left side. To remove a card from the lower slot, press the card eject button on the right side.

## Configuring and Operating PCMCIA Cards

To use a PCMCIA card with your system, it must be configured to operate properly with your software. For further details, refer to *Chapter 3: PCMCIA Drivers*, the README.TXT file on the included Utilities diskette, your software manual, and your PCMCIA card manual.

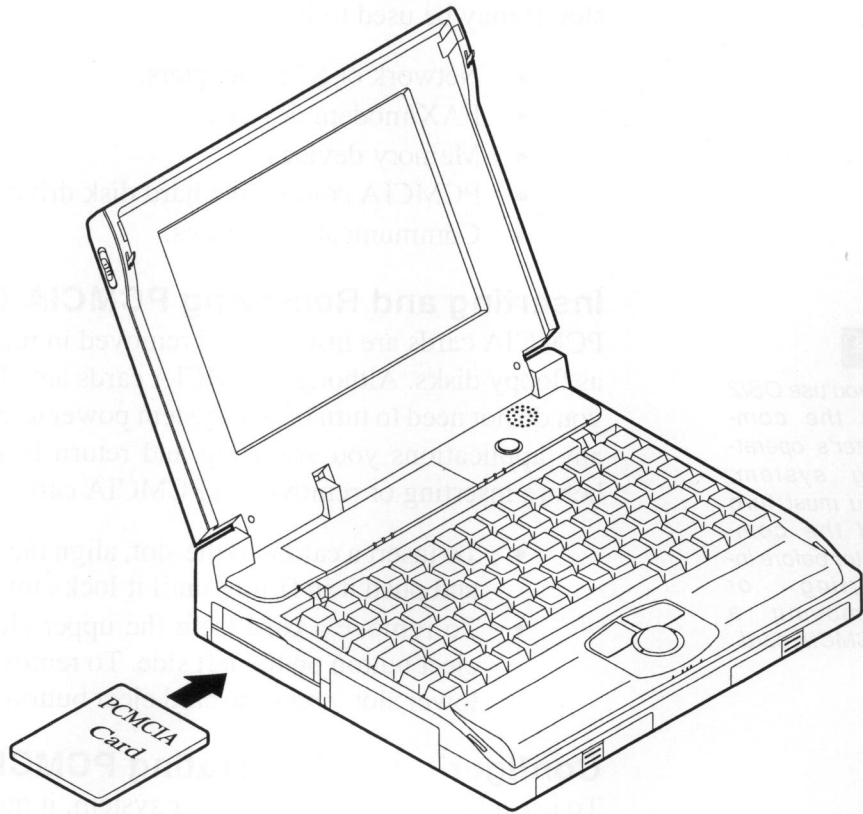

**Figure 2-11**  
*The Notebook Computer's PCMCIA slot*



## Audio System

Set up the programs included in the Utility diskette as an application to use with Windows.

## Trackball Pointing Device

The integrated trackball pointing device allows you to conveniently take advantage of software that requires a mouse whenever you are away from your desk. It features a large diameter ball with two “mouse buttons”.

The trackball is internally wired to PS/2 port of the Notebook Computer and requires no further hardware connections. Before using it, however, you must first activate it with an appropriate software driver. See your software manuals for further details.

You may disable the trackball from within the Notebook Computer BIOS Utility pop-up menu.

Please refer to *Chapter 3: Utilities, Trackball* for more information.



## External Monitor

An external VGA-compatible device may be connected to the system through the 15-pin external monitor port located on the rear side of the system unit. The Notebook Computer's video circuitry offers the following features:

- VESA local-bus controller.
  - Super-VGA resolution output to an external monitor.
  - Ability to drive internal and external displays simultaneously (SimulSCAN).
1. Connect an external monitor to the system.
  2. Use the Notebook Computer BIOS Utility to switch the display mode. Refer to *Chapter 3: Utilities, the BIOS Utility* for a detailed explanation on how to do this or the Utility diskette for more information.
  3. Some of the display features supported by the Notebook Computer BIOS Utility cannot be used with external monitors. Therefore, these features will become inactive after you switch operating modes.



The Notebook Computer...  
you get the most from the...  
the features found in...  
the BIOS Utility and the PCMCIA drivers. It discusses...

<h1><i>CHAPTER 3</i></h1>	<h1><i>Utilities</i></h1>
---------------------------	---------------------------



## *Overview*

The Notebook Computer has several built-in software utilities to help you get the most from the system hardware. This chapter describes the features found in the POST, the CMOS Setup Utility, the BIOS Utility, and the PCMCIA drivers. It discusses:

- The Power-On-Self-Test (POST).
- The CMOS Setup Utility.
- The BIOS Utility.
- PCMCIA Drivers.

## *Power-On Self Test (POST)*

Each time the system is turned on, it automatically performs a Power-On-Self-Test (POST). This test involves checking the microprocessor, keyboard, display screen and driver, system memory and most of the options connected to the system. It takes seconds to complete.



## POST Messages

### POST: Normal Operation

If no configuration errors are detected, the system will be operated after the POST process is completed.

BIOS Shadow RAM.....	Enabled
Video Shadow RAM .....	Enabled
Check 1st DMA Channel .....	Passed
Check 2nd DMA Channel.....	Passed
Check DMA Page Registers .....	Passed
Check Timer 2 .....	Passed
Check 1st Interrupt Controller .....	Passed
Check 2nd Interrupt Controller .....	Passed
Check Interrupt Functions.....	Passed
CPU Check .....	33MHz
Sizing System Memory .....	640K Found
Sizing Extended Memory.....	3072K Found
Testing System Memory at .....	640K OK
Testing System Memory at Address .....	4096K OK
Installing Mouse .....	Passed
Sizing Cache Memory .....	128K OK
External Cache Controller.....	Enabled
Installing Floppy Drive .....	Passed
Installing Fixed Disks .....	Passed



### **POST: Error Detected**

If a configuration error is detected, a message such as below will be displayed in a box in the middle of the screen. Upon encountering such a message, you should either press *F1* key to continue, or press *Ctrl-Alt-Esc* key combination simultaneously or *Del* key to enter the CMOS Setup Utility.

**Keyboard error or no keyboard present**

**<PRESS F1 TO CONTINUE, CTRL-ALT-ESC OR DEL TO ENTER SETUP>**

## POST Beep

There is only one beep code regarding POST to alert you of the system's status.

Beep Code	Meaning	Action
1 long beep followed by 2 short beeps	Video failure or improper video configuration.	Check the video adapter to be sure it is configured properly. If this is not the cause of the problem, the adapter may be damaged and will require repair or replacement.

Table 3-1  
POST beep



# The CMOS Setup Utility

The CMOS Setup Utility has a built-in Setup program which allows you to modify the basic system configuration. This type of information is stored in battery-backed RAM so that it retains the Setup information when the power is turned off.

## Information in the CMOS Setup Utility

Below shows the system settings that may be changed from within the CMOS Setup Utility.

Item	Setting
Standard CMOS Setup	Date, time, drive C (cylinders, heads, precomp, landzone and sectors), drive A, video, halt on.
BIOS Features Setup	External cache, quick POST, boot sequence, boot up floppy seek, boot up system speed, Gate A20 option, typematic rate setting, typematic rate (Chars/sec), typematic delay (Msec), security option, battery low sound, popup menu border style, power on sound, extended function, video BIOS shadow, C8000-CFFFF, D0000-D7FFF, D8000-DFFFF shadow.
Load BIOS Defaults	Load BIOS defaults into <i>BIOS Features Setup</i> .
Load Setup Defaults	Load Setup defaults into <i>BIOS Features Setup</i> .
Password Setting	Enter password.
IDE HDD Auto Detection	Automatically configure hard disk parameters.
Save & Exit Setup	Save datas to CMOS memory and exit Setup.
Exit Without Saving	Abandon all datas & exit Setup

**Table 3-2**  
*System settings of the CMOS Setup Utility*

## Invoking the CMOS Setup Utility

The CMOS Setup Utility is accessed when simultaneously press the *Ctrl*, *Alt*, and *Esc* keys or *Del* Key, and the following message is displayed near the bottom of the screen.

< TO ENTER SETUP BEFORE BOOT  
PRESS CTRL-ALT-ESC OR DEL KEY >

The above message only lasts seconds. If you miss it, the computer will access its boot process. You must reboot the system and try again within the time limit if you like to enter the CMOS Setup Utility.

The CMOS Setup Utility is shown in Figure 3-1.

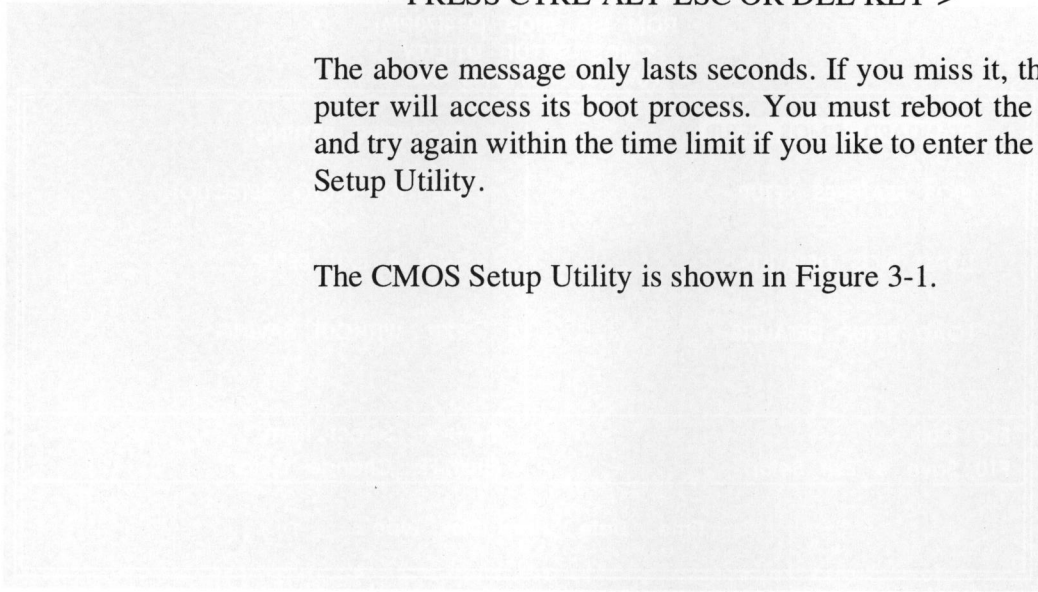

Figure 3-1  
The CMOS Setup Utility



## Making Changes in the Main Menu of the CMOS Setup Utility

The keys listed below are used to select a specific item for modifying values within the CMOS Setup Utility.

Action	Keys Used	Description
Enter the Setup menu	Ctrl-Alt-Esc or Del	Simultaneously press Ctrl-Alt-Esc key combination or Del key to enter the Setup menu.
Select items	Down arrow (↓) Up arrow (↑)  Left arrow (←) Right arrow (→)	Press the Down arrow to move to the next item. Press the Up arrow to move to the previous item.  Press the Left arrow to move to a item on the left. Press the Right arrow to move to a item on the right.
Quit	Esc Y, Enter N, Enter	Press the Esc key to quit the Setup menu. When "Quit Without Saving (Y/N)?" appears before quits the Setup menu, either type "Y" (Yes) and the Enter key to exit, or type "N" (No) and the Enter key to return to the Setup menu.
Save & exit setup	F10 Y, Enter N, Enter	Press the F10 key to save the Setup menu and exit. When "Save to CMOS and Exit (Y/N)?" appears before quits the Setup menu, either type "Y" (Yes) and the Enter key to have the Setup menu saved to CMOS memory and exit, or type "N" (No) and the Enter key to return to the Setup menu.
Change color	(Shift) F2	Press the F2 key to change the Setup menu's display mode to different colors for TFT/dual-scan STN panels and CRT monitor, or to different shades for Monochrome panel. Press the F2 key simultaneously with the Shift key to return to the previous color or shades.

**Table 3-3**  
Keys used to make changed in the main menu of the CMOS Setup Utility



## Making Changes in the Sub-menu of the CMOS Setup Utility

### Standard CMOS Setup

When *Standard CMOS Setup* is highlighted, press the Enter key to enter the item for modifying values.

Action	Keys Used	Description
Select item	Down arrow (↓) Up arrow (↑)  Left arrow (←) Right arrow (→)	Press the Down arrow to move to the next item. Press the Up arrow to move to the previous item. Press the Left arrow to move to a sub-item on the left. Press the Right arrow to move to a sub-item on the right.
Modify	PgUp or – (keypad) PgDn or + (keypad)	Press the PgUp key or the – key (keypad) to either decrease the values or move to the previous option. Press the PgDn key or the + key (keypad) to either increase the values or move to the next option.
Help	F1	Press the F1 key to load options available for reference. Press the F1 key again or the Esc key to exit help.
Toggle calendar	F3	Press the F3 key to load toggle calendar. Press the F3 key again to exit toggle calendar.
Change color	(Shift) F2	Press the F2 key to change the Setup menu's display mode to different colors for TFT/dual-scan STN panels and CRT monitor, or to different shades for Monochrome panel. Press the F2 key simultaneously with the Shift key to return to the previous color or shades.
Quit	Esc	Press the Esc key to exit <i>Standard CMOS Setup</i> .

**Table 3-4**  
*Keys used to make changed in Standard CMOS Setup*

## BIOS Features Setup

When *BIOS Features Setup* is highlighted, press the Enter key to enter the item for modifying values.

Action	Keys Used	Description
Select item	Down arrow (↓) Up arrow (↑)  Left arrow (←) Right arrow (→)	Press the Down arrow to move to the next item. Press the Up arrow to move to the previous item. Press the Left arrow to move to the item on the left. Press the Right arrow to move to the item on the right.
Modify	PgUp or – (keypad) PgDn or + (keypad)	Press the PgUp key or the – key (keypad) to either move to the previous option or to decrease the values. Press the PgDn key or the + key (keypad) to either move to the next option or to increase the values.
Help	F1	Press the F1 key to load options available for reference. Press the F1 key again or the Esc key to exit help.
Old values	F5	Load old values, which are last successfully saved, into <i>BIOS Features Setup</i> .
Load BIOS defaults	F6	Load BIOS defaults into <i>BIOS Features Setup</i> .
Load Setup defaults	F7	Load Setup defaults into <i>BIOS Features Setup</i> .
Change color	(Shift) F2	Press the F2 key to change the Setup menu's display mode to different colors for TFT/dual-scan STN panels and CRT monitor, or to different shades for Monochrome panel. Press the F2 key simultaneously with the Shift key to return to the previous color or shades.
Quit	Esc	Press the Esc key to exit <i>BIOS Features Setup</i> .

**Table 3-5**  
*Keys used to make changed in BIOS Features Setup*



### Load BIOS Defaults

When *Load BIOS Defaults* is highlighted, press the Enter key to enter the item for modifying values.

Action	Keys Used	Description
Modify	Y, Enter N, Enter	When "Load BIOS Defaults (Y/N)?" appears, either type "Y" (Yes) and the Enter key to load BIOS defaults into <i>BIOS Features Setup</i> , or type "N" (No) and the Enter key to return to the Setup menu.

**Table 3-6**  
*Keys used to make changed in Load BIOS Defaults*

### Load Setup Defaults

When *Load Setup Defaults* is highlighted, press the Enter key to enter the item for modifying values.

Action	Keys Used	Description
Modify	Y, Enter N, Enter	When "Load Setup Defaults (Y/N)?" appears, either type "Y" (Yes) and the Enter key to load Setup defaults into <i>BIOS Features Setup</i> , or type "N" (No) and the Enter key to return to the Setup menu.

**Table 3-7**  
*Keys used to make changed in Load Setup Defaults*

## Password Setting

When *Password Setting* is highlighted, press the Enter key to enter the item.

Action	Keys Used	Description
Enter password	Any keys (up to 8 characters) Enter	Type any keys up to 8 characters. The same keys are used for password confirmation.
	Esc	Abort the selection and not enter a password.
	Enter	Disable password.

**Table 3-8**

*Keys used to make changed in Password Setting*

## IDE HDD Auto Detection

When *IDE HDD Auto Detection* is highlighted, press the Enter key to enter the item.

Action	Keys Used	Description
Modify	Y, Enter N, Enter	When "Select Drive C Option" appears, either type "Y" (Yes) and the Enter key to accept the drive or type "N" (No) and the Enter key to skip it.
Skip	Esc	Skip the sub-menu.

**Table 3-9**

*Keys used to make changed in IDE HDD Auto Detection*



### Save & Exit Setup

When *Save & Exit Setup* is highlighted, press the Enter key to enter the item.

Action	Keys Used	Description
Modify	Y, Enter N, Enter	When "Save to CMOS and exit (Y/N)?" appears, either type "Y" (Yes) and the Enter key to have the Setup saved to CMOS memory and exit the Setup menu, or type "N" (No) and the Enter key to return to the Setup menu.

Table 3-10

*Keys used to make changed in Save & Exit Setup*

### Exit Without Saving

When *Exit Without Saving* is highlighted, press the Enter key to enter the item.

Action	Keys Used	Description
Modify	Y, Enter N, Enter	When "Exit Without Saving (Y/N)?" appears, either type "Y" (Yes) and the Enter key to abandon all CMOS value changes and exit the setup menu, or type "N" (No) and the Enter key to return to the Setup menu.

Table 3-11

*Keys used to make changed in Exit Without Saving*

## Features of the CMOS Setup Utility

### Standard CMOS Setup

Item	Setting	Function
Date (mm:dd:yy)	Day Month Date Year	Set the current date.
Time (hh:mm:ss)	Hour Minute Second	Set the current time. e.g. 1 p.m. is 13:00:00.
Drive C	None	No hard disk is installed.
	User (type)  (Type) 1- 46	"User type" allows users to define the number of cylinders, heads, precomp, landzone, sectors and type of mode. Once a type is selected, the number of cylinders, heads, precomp, landzone, sectors and type of mode will be automatically defined.
Drive A	None	Disables the floppy disk drive
	360K, 5.25 in.	5.25 inch diskette in 360 kilobyte capacity
	1.2M, 5.25 in	5.25 inch diskette in 1.2 megabyte capacity
	720K, 3.5 in.	3.5 inch diskette in 720 kilobyte capacity
	1.44M, 3.5 in.	3.5 inch diskette in 1.44 megabyte capacity
Video	2.88M, 3.5 in.	3.5 inch diskette in 2.88 megabyte capacity
	EGA/VGA	Enhanced Graphics Adapter / Video Graphics Array. For EGA, VGA, SEGA, or PGA monitor adapters.
	CGA40	Color Graphics Adapter, power up in 40 column mode.
	CGA80	Color Graphics Adapter, power up in 80 column mode.
	MONO	Monochrome adapter, includes high resolution monochrome adapters.



Item	Setting	Function
Halt on	All errors	Whenever the BIOS detects a non-fatal error, the system will stop and prompt the user.
	No errors	The system boot will not stop for any errors that are detected.
	All, but keyboard	The system boot will stop for all errors but a keyboard error.
	All, but diskette	The system boot will stop for all errors but a diskette error.
	All, but diskette/key	The system boot will stop for all errors but a diskette or keyboard error

**Table 3-12**  
*Setting for Standard CMOS Setup*



ROM ISA BIOS (214I70PM)  
CMOS SETUP UTILITY  
AWARD SOFTWARE, INC.

---

Date (mm:dd:yy) : Thu, **Oct** 21 1993  
Time (hh:mm:ss) : 8 : 27 : 4

	CYLS.	HEADS	PRECOMP	LANDZONE	SECTORS	MODE
Drive C : User (520Mb)	1057	16	65535	1056	63	Normal

Drive A : 1.44M, 3.5 in.

Video : EGA/VGA

Halt on : ALL Errors

Base Memory : 640K  
Extended Memory : 3072K  
Expanded Memory : 0K  
Other Memory : 384K  

---

Total Memory : 4096K

---

Esc : Quit                      ↑↓ → ← : Select Item                      PU/PD/+/- : Modify  
F1 : Help                        (Shift) F2 : Change Color                      F3 : Toggle Calendar

3

**Figure 3-2**  
Standard CMOS Setup



## BIOS Features Setup

Item	Setting	Defaults	Function
External cache	Enabled	BIOS, Setup	If external cache installed.
	Disabled		If external cache not installed.
Quick power on self test	Enabled	Setup	Enables Quick POST.
	Disabled	BIOS	Enables Normal POST.
Boot sequence	A, C	BIOS	First searches for floppy disk drive, then hard disk drive.
	C, A	Setup	First searches for hard disk drive, then floppy disk drive.
Boot up floppy seek	Enabled	BIOS	Enables search for floppy disk drive to determine 40 or 80 tracks.
	Disabled	Setup	Disables search for floppy disk drive type by track number.
Boot up system speed	Low	BIOS	Set low speed.
	High	Setup	Set high speed.
Gate A20 option	Normal	BIOS	Keyboard.
	Fast	Setup	Chipset.
Typematic rate setting	Enabled		Enables typematic rate.
	Disabled	BIOS, Setup	Disables typematic rate.
Typematic rate (Chars/sec)	6, 8, 10, 12, 15, 20, 24, 30	6 for both BIOS and Setup defaults	e.g. 6 characters per second.
Typematic delay (Msec)	250, 500, 750, 1000	250 for both BIOS and Setup defaults	Set the time between the first and second character displayed.
Security option	System		System won't boot and access to Setup is denied if incorrect password.
	Setup	BIOS, Setup	System will boot but access to Setup is denied if incorrect password.
Battery low sound	Enabled	BIOS, Setup	The system will sound when the power of both battery packs is low.
	Disabled		The system will not sound when the power of both battery packs is low.

Item	Setting	Defaults	Function
Popup menu border style	Line	BIOS, Setup	The pop-up menu will be displayed in the line style border.
	ASCII		The pop-up menu will be displayed in the ASCII style border.
Power on sound	Enable	BIOS, Setup	Enables system power on sound.
	Disable		Disables system power on sound.
Extended function	Fn	BIOS	Uses the Notebook Computer's special Fn key to change system settings with the BIOS Utility. Changes may be performed directly known as immediate mode or via a pop-up menu.
	Ctrl+Alt+Esc	Setup	Uses the Ctrl+Alt+Esc key combination to change system settings with the BIOS Utility. Changes may <i>only</i> be performed via a pop-up menu.
Video BIOS shadow	Enabled	Setup	Enables video shadow.
	Disabled	BIOS	Disables video shadow.
C8000-CFFFF shadow	Enabled		Enables optional shadow.
	Disabled	BIOS, Setup	Disables optional shadow.
D0000-D7FFF shadow	Enabled		Enables optional shadow.
	Disabled	BIOS, Setup	Disables optional shadow.
D8000-DFFFF shadow	Enabled		Enables optional shadow.
	Disabled	BIOS, Setup	Disables optional shadow.

**Table 3-13**  
Setting for BIOS Features Setup

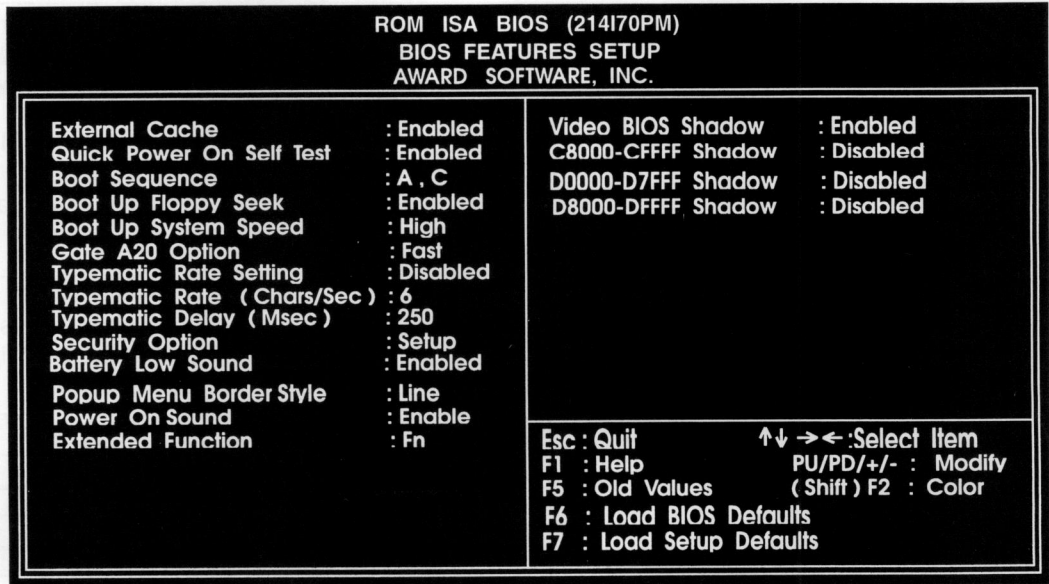

Figure 3-3  
BIOS Features Setup

## Load BIOS Defaults

Item	Setting	Function
Load BIOS defaults	Yes	BIOS defaults will be loaded into <i>BIOS Features Setup</i>
	No	BIOS defaults will not be loaded into <i>BIOS Features Setup</i> .

**Table 3-14**  
Setting for Load BIOS Defaults

3

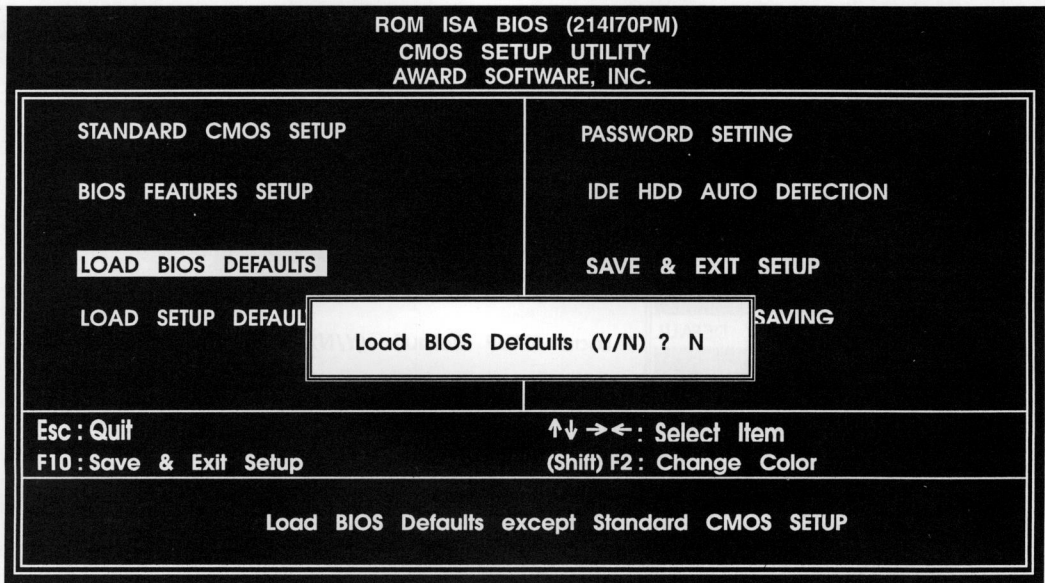

**Figure 3-4**  
Load BIOS Defaults



## Load Setup Defaults

Item	Setting	Function
Load Setup defaults	Yes	Setup defaults will be loaded into <i>BIOS Features Setup</i>
	No	Setup defaults will not be loaded into <i>BIOS Features Setup</i> .

Table 3-15  
Setting for Load Setup Defaults

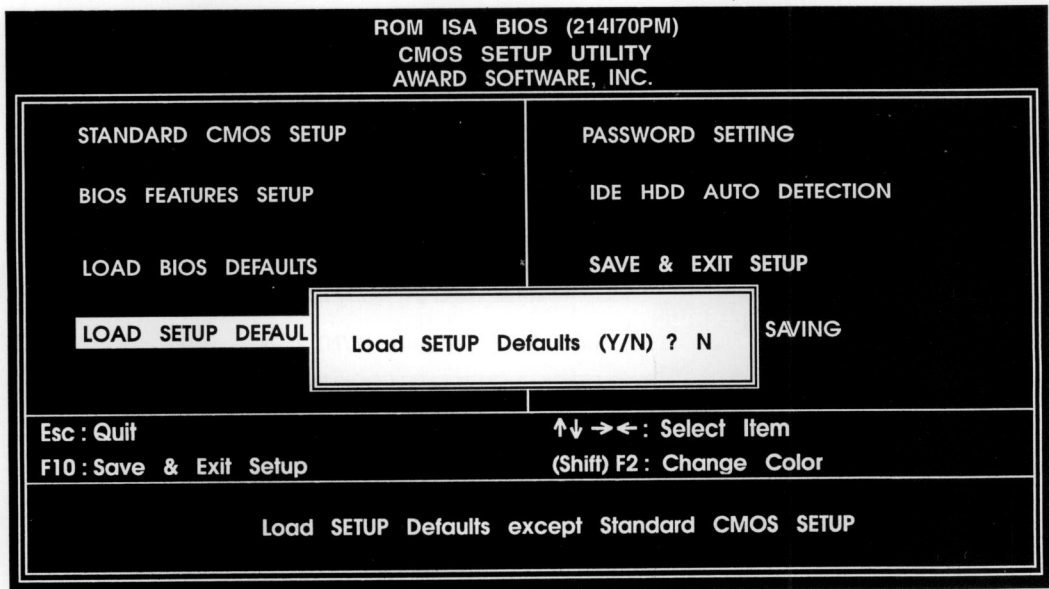

Figure 3-5  
Load Setup Defaults





## IDE HDD Auto Detection

The system automatically configures hard disk parameters.

```
ROM ISA BIOS (214I70PM)
CMOS SETUP UTILITY
AWARD SOFTWARE, INC.
```

		CYLS.	HEADS	PRECOMP	LANDZONE	SECTORS	MODE
<b>Drive c</b>	: User (520Mb)	1057	16	65535	1056	63	Normal

Select Drive C Option (N:Skip) : N

OPTION	SIZE	CYLS.	HEADS	PRECOMP	LANDZONE	SECTORS	MODE
1 (Y)	520	1057	16	65535	1056	63	Normal
2	519	528	32	0	1056	63	LBA
3	519	528	32	65535	1056	63	LARGE

Esc : Skip

**Figure 3-7**  
*IDE HDD Auto Detection*

## Save & Exit Setup

Item	Setting	Function
Save to CMOS and exit	Yes	Save the CMOS value changes to CMOS and exit the Setup Utility.
	No	Not to save the CMOS value changes to CMOS and exit the the Setup Utility.

**Table 3-16**  
Setting for Save & Exit Setup

3

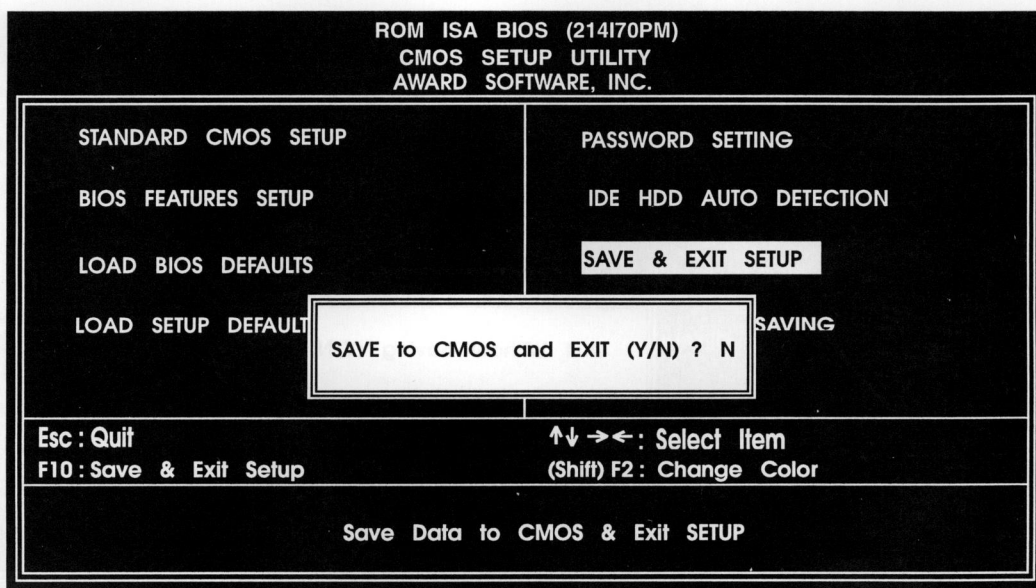

**Figure 3-8**  
Save & Exit Setup



# The BIOS Utility

The Notebook Computer has special control features built into its BIOS. They are used to control a variety of system functions.

## Operating Modes

You can access the BIOS Utility by either:

### Pop-up Menu Mode

Use a pop-up menu to help you change BIOS settings.

- A. Depending on the setting of the Extended Function of *BIOS Features Setup* within the CMOS Setup Utility, press the *Fn-Esc* or the *Ctrl-Alt-Esc* key combination to enter the BIOS Utility pop-up menu.
- B. Use the following keys to make selections within the pop-up menu:

Key	Function
Up / Down arrow keys	Move between fields.
Right / Left arrow keys	Change field settings.
PgUp / PgDn keys	Change pages.
F1 key	Pop-up help menu describing the currently active field.
S key	Save settings.
Esc key	Exit the pop-up menu.

**Table 3-18**  
*Keys used with the pop-up menu utility*



### **Immediate Mode**

Press key combinations to directly change BIOS settings if *FN* is set for the Extended Function of *BIOS Features Setup* within the CMOS Setup Utility to enable the system function key.

Press the *Fn* and *m* keys together to lock the *Fn* key function. The *Fn* indicator light will turn on and the keyboard will respond as if the *Fn* key is continuously being held down.

Press the *Fn* and *m* keys together a second time to unlock the *Fn* key function.

The immediate mode for the contrast, brightness and volume control however always works even if *FN* is not set as above.

## Features of the BIOS Utility

Below shows system features which may be modified with the BIOS Utility and the keys used to make changes.

Feature	Option	Function	Changing Settings
Text Reverse (Monochrome and dual-scan STN applied)	Reverse	Displays characters black on white.	Pop-up menu.
	Normal	Displays characters white on black.	Immediate Mode. <b>Fn key + F2 key</b>
Grap Reverse (Monochrome and dual-scan STN applied)	Reverse	Displays pixels black on white.	Pop-up menu.
	Normal	Displays pixels white on black.	Immediate Mode. <b>Fn key + F3 key</b>
Expanded Mode (panel only)	Enable	Controls vertical expansion of the text and graphics modes to fill the screen as much as possible.	Pop-up menu. Immediate Mode. <b>Fn key + F4 key</b>
	Disable	Disables the above function.	
Centering Mode (panel only)	Center	Aligns the display area with the center position.	Pop-up menu.
	Top	Aligns the display area with the top position.	Immediate Mode. <b>Fn key + F5 key</b>
	Bottom	Aligns the display area with the bottom position.	
Display Type (The CRT mode setting cannot be saved)	Panel	Activates the system's display panel.	Pop-up menu.
	CRT	Activates an externally connected monitor.	Immediate Mode. <b>Fn key + F6 key</b>
	SIMUL	Activates both the display panel and an external monitor simultaneously.	
Track Ball	Enable	Enables the built-in trackball.	Pop-up menu only, when Extended Function in <i>BIOS Features Setup</i> is set as Ctrl+Alt+Esc.
	Disable	Disables the built-in trackball.	



Feature	Option	Function	Changing Settings
HDD Sleep	Off	Disables the hard disk drive sleep feature.	Pop-up menu only.
	3	Turns off the HDD motor after about 3 minutes of HDD inactivity.	
	6	Same as above, 6 minutes.	
	9	Same as above, 9 minutes.	
	12	Same as above, 12 minutes.	
	15	Same as above, 15 minutes.	
PMU Switch	Enable	Turns on the system power management unit.	Pop-up menu only.
	Disable	Turns off the system power management unit.	
Contrast		Adjust the contrast of the display panel. <i>(Models with TFT active matrix displays do not have a contrast control.)</i>	Pop-up menu.  Immediate Mode. <b>Fn key + F7 key</b> <b>Fn key + F8 key</b>
Brightness		Adjust the brightness of the display panel.	Pop-up menu.  Immediate Mode. <b>Fn key + F9 key</b> <b>Fn key + F10 key</b>
Volume		Adjust the volume of the audio system.	Pop-up menu.  Immediate Mode. <b>Fn key + F11 key</b> <b>Fn key + F12 key</b>

**Table 3-19**  
*Features of the BIOS Utility*

## Feature Descriptions

### Power Management Unit (PMU)

The Notebook Computer features a hardware-based, non-event driven power management unit. It reduces power consumption and lowers system operating temperature by automatically switching the CPU from turbo to standard speed whenever the CPU is not processing an instruction. The PMU can be enabled or disabled from within the BIOS Utility pop-up menu.

### Display Features

The Notebook Computer supports several features designed to enhance the output of its display panel:

#### *Text Reverse Display Mode*

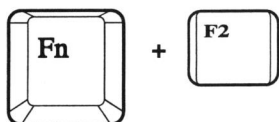

Text Reverse display mode allows you to switch between viewing white characters on a black background or black characters on a white background. This feature is available for monochrome and dual-scan STN displays.

#### *Graphics Reverse Display Mode*

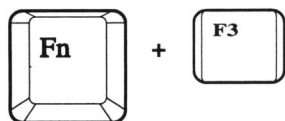

Graphics Reverse display mode allows you to switch between viewing white pixels on a black background or black pixels on a white background. This feature is available for monochrome and dual-scan STN displays.

#### *Expanded Display Mode*

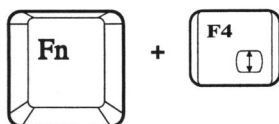

The aspect ratio of display panels is not the same as CRT monitors. Therefore, the display may not completely fill the entire display panel. Expanded mode will stretch the display to fill the entire viewing area of the display panel.



### Centering Display Mode

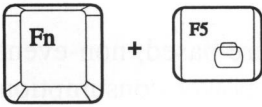

When the expanded mode is not used, the display will shift to the top of the screen leaving a blank band at the bottom. Centering mode moves the display to the center of the display panel. Bottom mode moves the display to the bottom of the display panel.

### Display Type

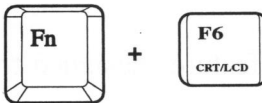

Display type mode allows you to switch between the display panel, an external monitor, or to show them simultaneously. You may not save the CRT mode setting; this prevents your screen from blanking and causing you to lose control of the system.



## Trackball

The built-in trackball, which is internally connected to the PS/2 port, facilitates the convenient use with Windows or any other applications in which the pointing device is preferred.

Trackball will be always enabled when the Extended Function of *BIOS Features Setup* is set as *FN* instead of *CTRL+ALT+ESC*. Trackball Switch in the pop-up menu, therefore under such a setting, will not be displayed for selection.

### *Special Procedures for Windows Users to Use Pointing Devices*

Use WMPRESET included in the utility diskette to make the built-in trackball or other mouse (Microsoft type if there is any) active under Windows:

WMPRESET/P : Trackball (PS/2 type)

WMPRESET/1 : Mouse connected (COM1)

WMPRESET/2 : Mouse connected (COM2)

When installing Windows 3.1, choose Microsoft or IBM PS/2 as the mouse type under *Windows setup* to activate pointing devices.



## Sleep/Power Conservation Features

The BIOS Utility offers a function to conserve system power consumption while some part of the system is not actively being used.

### *HDD*

HDD sleep turns off the Notebook Computer's hard disk drive motor if it has not been accessed after a certain period of time. The motor will be turned on again the next time the system attempts to read or write data to it.

### *Panel*

Panel sleep shuts off the Notebook Computer's display panel backlight after a certain period of keyboard inactivity. The display panel backlight will be turned on again the next time any key is pressed.

Panel sleep function is able to be activated by the three programs included in the utility diskette:

LCDSLEEP	EXE
WINLCD	EXE
DLLLCD	DLL

Copy these programs to the hard diskette. Make WINLCD.EXE and DLLLCD.DLL under the same directory.

### *Panel Sleep under DOS Prompt*

Panel sleep tool under DOS prompt: LCDSLEEP.EXE.

The default value of LCDSLEEP.EXE is 3 (minutes). The first time to activate LCDSLEEP.EXE will load the default value as following:

```
C:\>LCDSLEEP  
  
LCDSLEEP V.1.00  
Sleep time = 03 minutes.
```

You may run LCDSLEEP.EXE and specify a parameter in the range from 0 (disable) to 30 (unit:minute) for the sleep time setting, for example:

```
C:\>LCDSLEEP 6
LCDSLEEP V.1.00
Sleep time = 06 minutes.
```

The next time to run LCDSLEEP.EXE will display the information of the panel sleep time you specified, for example:

```
C:\>LCDSLEEP
LCDSLEEP V.1.00
Sleep time = 06 minutes.
```

### Panel Sleep under Windows 3.1

Panel sleep tools under Windows 3.1: WINLCD.EXE & DLLLCD.DLL.

Run WINLCD.EXE under DOS prompt before you enter Windows 3.1 to set the panel sleep time in the *Notebook Utility* application.

```
C:\>WIN WINLCD
```

You may disable the panel sleep or select the panel sleep time in the range from 1 to 30 (unit:minute) and save the setting.

Keep the *Notebook Utility* opened to make WINLCD.EXE active until you exit Windows 3.1.

You may, however, make WINLCD.EXE a Terminate & Stay Resident program as one of the StartUp group under Windows 3.1 to avoid the above-mentioned procedures.



## Display Control Features

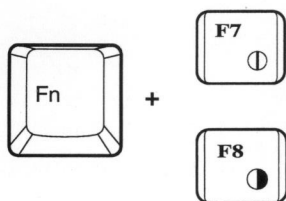

### *Contrast Control*

Contrast control allows you to adjust the contrast of the display panel.

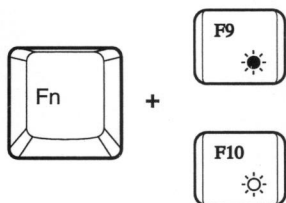

### *Brightness Control*

Brightness control allows you to adjust the brightness of the display panel.

## Audio System Control Features

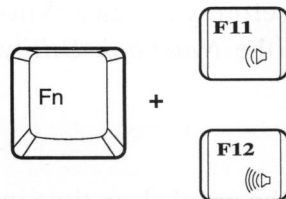

### *Volume Control*

Volume control allows you to adjust the volume of the audio system.

# PCMCIA Drivers

## Description

The Notebook Computer's PCMCIA expansion socket requires the use of software drivers to control the operation of the socket and any PCMCIA cards inserted into it. Provided with the Notebook Computer is a utilities diskette that includes several PCMCIA software drivers:

### Socket Services

Socket Services gives the Notebook Computer a standard software interface to allow different PCMCIA cards to be used with the system.

### Card Services

Card Services coordinates the activities of PCMCIA cards, sockets, and system resources among the software programs, utilities, and drivers that call upon them.

### Other Drivers

Various other drivers are available for different PCMCIA cards that you might attach to the system. They are device and application specific. You will need special drivers for:

- Memory cards
- SRAM cards
- Windows applications
- IDE (hard drive)
- Communication cards (FAX/modem)



## **Installation and Usage**

In order to use a PCMCIA card with your system, you will have to:

1. Install the *Socket Services* driver to activate the socket.
2. Install the *Card Services* driver to prepare the system.
3. Install device specific drivers designed to work with the PCMCIA cards you will install.

PCMCIA drivers are constantly be written and revised as the list of available PCMCIA devices grows. Therefore, we have included the latest available drivers and instructions on how to use them on the PCMCIA diskette. Please refer to the Utility diskette for further instructions.

# *Appendices*

## *Overview*

The following appendices provide the following information:

- System specifications.
- I/O port pin assignments.
- Keyboard scan and ASCII codes.
- Sound switch configuration.

## Appendix A: Specifications

CPU (one of the following)	486DX-33 486DX2-66 486DX2-50 486SX-25 486SX-33 486DX4-75 486DX4-100
JP4 Setting for Type Select	
DX	Pin 9-10, 13-14 on
SX	Pin 11-13, 10-12 on
JP4 Setting for Clock Select	
25 MHz	Pin 2-4, 5-6, 7-8 on
33.33 MHz	Pin 2-4, 5-7, 6-8 on
DC-to-DC	
JP1 Setting	
SX, DX, DX2	Pin 2-4 on
DX4	Pin 3-4 on
I/O Address Default	22X Hex
BIOS	Award
Intelligent Power Management	DIA
Cache Memory (optional)	128K
On-board DRAM	
Base configuration	4MB
Maximum configuration	36MB
System and Video ROM	128K
Video RAM	1MB
I/O	
PCMCIA	Type IV
Driver	SystemSoft
Trackball	PS/2
Serial Port	1 (1 external 9-pin connector)
Parallel Port	1 (25-pin Centronics compatible) EPP / ECP mode support
External Video Port	1 (15-pin)
External keyboard port	1 (fully PS/2 compatible)
Expansion Port	1 (200-pin)

Disk Drives	
Hard Disk Drive	2.5", IDE type (removable)
Floppy Disk Drive	3.5", high-density type, 1.44MB
Audio System	Microsoft sound system
	Sound Blaster compatible (note)
(Note)	Compatible with Sound Blaster version 2.01 voice I/O functions as documented in the Sound Blaster Series Developer Kit (except 44KHz playback).
Power Supply	Universal, auto-sensing, switching type
Input	90~264VAC @ 47~63Hz, 0.8A
Output	
DC	18V, 1.5A
Battery Packs	NiCD or NiMH
Voltage	9.6V
Capacity	1400mAh (NiCDx8) / 1800mAh (NiMHx8)
Recharge Time	60 minutes per NiCD pack
	90 minutes per NiMH pack
Keyboard	86-key, multi-functional
Physical Specifications	
Weight	3kg
Size	280mm(w) x 220mm(d) x 50mm(h) (Mono)
	280mm(w) x 220mm(d) x 54mm(h) (Color)
Temperature	
Storage	-10°~50° c
Operation	0°~35° c
Humidity	
Storage	0%~90%, non-condensing
Operation	20%~85%, non-condensing
Altitude	2500 m
Shock	2G 10+/- microsecond pulse

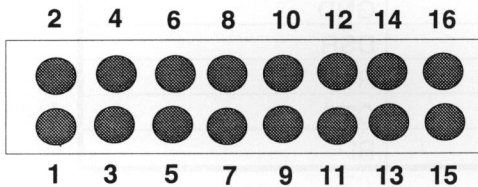

*Enlarged view of JP4 pin location*

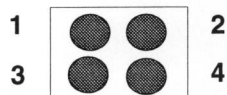

*Enlarged view of JP1 pin location*

## Appendix B: I/O Port Pin Assignments

### Parallel Port

Pin	Signal	Pin	Signal
1	STROBE	14	AUTOFD
2	D0	15	ERROR
3	D1	16	INIT
4	D2	17	SLCTIN
5	D3	18	GND
6	D4	19	GND
7	D5	20	GND
8	D6	21	GND
9	D7	22	GND
10	ACK	23	GND
11	BUSY	24	GND
12	PE	25	GND
13	SLCT		

### Serial Port

Pin	Signal
1	DCD
2	RD
3	SD
4	DTR
5	GND
6	DSR
7	RTS
8	CTS
9	RI

## Monitor Port

Pin	Signal	Pin	Signal
1	R	9	NC
2	G	10	GND
3	B	11	NC
4	NC	12	NC
5	GND	13	HSYNC
6	GND	14	VSYNC
7	GND	15	NC
8	GND		

## PCMCIA Port

Pin	Signal	Pin	Signal	Pin	Signal
1	GND	24	A5	47	A18
2	D3	25	A4	48	A19
3	D4	26	A3	49	A20
4	D5	27	A2	50	A21
5	D6	28	A1	51	VCC
6	D7	29	A0	52	VPP2
7	CE1	30	D0	53	A22
8	A10	31	D1	54	A23
9	OE	32	D2	55	A24
10	A11	33	CARD16	56	A25
11	A9	34	GND	57	RFU
12	A8	35	GND	58	RESET
13	A13	36	CD1	59	WAIT
14	A14	37	D11	60	INPACK
15	WE/PGM	38	D12	61	REQ
16	IREQ	39	D13	62	SPKR
17	VCC	40	D14	63	CHSTS
18	VPP1	41	D15	64	D8
19	A16	42	CE2	65	D9
20	A15	43	RFSH	66	D10
21	A12	44	IORD	67	CD2
22	A7	45	IOWR	68	GND
23	A6	46	A17		

## Appendix C: Keyboard Scan and ASCII Codes

Key*	Scan Code	ASCII	Key	Scan Code	ASCII
a	1E	61	A	1E	41
b	30	62	B	30	42
c	2E	63	C	2E	43
d	20	64	D	20	44
e	12	65	E	12	45
f	21	66	F	21	46
g	22	67	G	22	47
h	23	68	H	23	48
i	17	69	I	17	49
j	24	6A	J	24	4A
k	25	6B	K	25	4B
l	26	6C	L	26	4C
m	32	6D	M	32	4D
n	31	6E	N	31	4E
o	18	6F	O	18	4F
p	19	70	P	19	50
q	10	71	Q	10	51
r	13	72	R	13	52
s	1F	73	S	1F	53
t	14	74	T	14	54
u	16	75	U	16	55
v	2F	76	V	2F	56
w	11	77	W	11	57
x	2D	78	X	2D	58
y	15	79	Y	15	59
z	2C	7A	Z	2C	5A
1	02	31	!	02	21
2	03	32	@	03	40
3	04	33	#	04	23
4	05	34	\$	05	24
5	06	35	%	06	25
6	07	36	^	07	5E
7	08	37	&	08	26
8	09	38	*	09	2A

Key	Scan Code	ASCII	Key	Scan Code	ASCII
9	0A	39	(	0A	28
0	0B	30	)	0B	29
F1	3B	00	(shift) F1	54	00
F2	3C	00	(shift) F2	55	00
F3	3D	00	(shift) F3	56	00
F4	3E	00	(shift) F4	57	00
F5	3F	00	(shift) F5	58	00
F6	40	00	(shift) F6	59	00
F7	41	00	(shift) F7	5A	00
F8	42	00	(shift) F8	5B	00
F9	43	00	(shift) F9	5C	00
F10	44	00	(shift) F10	5D	00
'	29	60	~	29	7E
-	0C	2D	Underline	0C	5F
=	0D	3D	+	0D	2B
Backspace	0E	08			
Tab (right)	0F	09	Tab (left)	0F	00
[	1A	5B	{	1A	7B
]	1B	5D	}	1B	7D
\	2B	5C		2B	7C
;	27	3B	:	27	3A
'	28	27	"	28	22
Enter	1C	0D			
,	33	2C	<	33	3C
.	34	2E	>	34	3E
/	35	2F	?	35	3F
↑	48	00			
↓	50	00			
→	4D	00			
←	4B	00			
PgUp	49	00			
PgDn	51	00			
Home	47	00			
End	4F	00			
Del	53	00			
Ins	52	00			

## Appendix D: Sound Switch Configuration

Load Point On	Signal
SW1-1	DRQ1
SW1-2	DRQ3
SW1-3	IRQ3
SW1-4	IRQ5
SW1-5	IRQ7
SW1-6	DACK1
SW1-7	DACK3
SW1-8	Not used

